

PART 2:

GAMEPLAY GUIDE



TABLE OF CONTENTS

	page*		page*		
1	Installation	43	6	Multiplayer	66
2	Training	43	6.1	Skirmish vs. CPU	66
2.1	Starting the Training	43	6.2	LAN	66
2.2	Saving a Lesson	43	6.2.1	Play LAN Game	66
2.3	Loading a Lesson	43	6.2.2	The Lobby	67
3	Game Controls	45	6.2.3	Setup Game	68
3.1	Camera Controls	45	6.2.4	Waiting for Players	69
3.2	Ship Selection	46	6.3	Internet	70
3.3	The Rightclick Menu	46	6.3.1	Logging In	70
3.4	Movement	47	6.3.2	WON Lobby	71
3.5	Combat	48	6.3.3	Available Games	72
3.6	Formations and Tactics	49	6.3.4	Available Rooms	73
3.7	Other Commands	54	6.4	Setting Multiplayer Game Options	74
3.8	Misc. Commands	55	6.5	Saving a Multiplayer game	75
3.9	Multiplayer Controls	56	6.6	Loading a Multiplayer game	75
3.10	Technology Tree	57	6.7	Recording a Multiplayer game	75
4	Managers and Overlays	59	7	Options	77
4.1	Interface Overlays	59	7.1	Audio Options	77
4.2	The Manager Screens	60	7.2	Video Options	78
4.2.1	The Build Manager	60	7.3	Gameplay Options	80
4.2.2	The Research Manager	61	7.4	Key Bindings	81
4.2.3	The Sensors Manager	62	8	Ship Data	83
4.2.4	The Launch Manager	63	8.1	Ship Categories	83
5	Single Player	64	8.2	Ship Stats and Descriptions	84
5.1	Starting a Game	64	8.2.1	Scout	85
5.2	Characters	65	8.2.2	Interceptor	85
5.3	Mission Objectives	65	8.2.3	Defender	85
			8.2.4	Cloaked Fighter	86
			8.2.5	Attack Bomber	86
			8.2.6	Defense Fighter	86



	page*		page*		
8.2.7	Light Corvette	87	9.8	Super-Capital Ship Drive	99
8.2.8	Heavy Corvette	87	9.9	Defense Fighter (Taiidan Only)	99
8.2.9	Repair Corvette	87	9.10	Defense Field (Taiidan Only)	100
8.2.10	Salvage Corvette	88	9.11	Drone Technology (Kushan Only)	100
8.2.11	Multi-Gun Corvette	88	9.12	Fast-Tracking Turrets	100
8.2.12	Minelayer Corvette	88	9.13	Fighter Drive	101
8.2.13	Assault Frigate	89	9.14	Sensor Array	101
8.2.14	Ion Cannon Frigate	89	9.15	Defender Sub-Systems	101
8.2.15	Support Frigate	89	9.16	Gravity Generator	102
8.2.16	Drone Frigate	90	9.17	Guided Missiles	102
8.2.17	Defense Field Frigate	90	9.18	Heavy Corvette Upgrade	102
8.2.18	Missile Destroyer	91	9.19	Fighter Chassis	103
8.2.19	Carrier	91	9.20	Heavy Guns	103
8.2.20	Heavy Cruiser	91	9.21	Ion Cannons	103
8.2.21	Destroyer	92	9.22	Minelaying Tech	104
8.2.22	Mothership	92	9.23	Plasma Bomb Launcher	104
8.2.23	Resource Collector	93	9.24	Proximity Detector	104
8.2.24	Resource Controller	93			
8.2.25	Probe	93			
8.2.26	Cloak Generator	94			
8.2.27	GravWell Generator	94			
8.2.28	Proximity Sensor	94			
8.2.29	Sensors Array	95			
8.2.30	Research Ship	95			
9	Technologies	97			
9.1	Capital Ship Chassis	97			
9.2	Capital Ship Drive	97			
9.3	Super-Heavy Chassis	97			
9.4	Cloaked Fighter (Kushan Only)	98			
9.5	Cloak Generator	98			
9.6	Corvette Chassis	98			
9.7	Corvette Drive	99			

1 INSTALLATION

Insert the CD-ROM into your CD-ROM drive. The Homeworld Installation program will automatically start up. Follow the on-screen instructions to specify the various installation options. When the installation is complete, it will have created a shortcut in your Start Menu that you can use to run Homeworld.

2 TRAINING screen shot

2.1 Starting the Training

It's strongly recommended you pass the Homeworld training section before starting a singleplayer or multiplayer game. It's easy to do and it will teach you all the essential controls of the game.

To start the training, leftclick on the <TRAINING> button in the Main Menu, then leftclick on <BEGIN TRAINING>.

2.2 Saving a Lesson

Your progress will be saved automatically at the beginning of each lesson. You can therefore quit the tutorial at any time and restart it where you left off.

2.3 Loading a Lesson



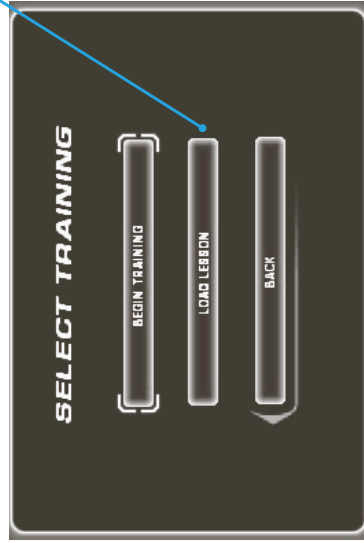



To load a lesson from the Main Menu, leftclick on the <TRAINING> button, then on the <LOAD LESSON> button. Select the saved lesson from the list, then leftclick on the <LOAD LESSON> button.









3 GAME CONTROLS

3.1 CAMERA CONTROLS

COMMAND	ACTION	COMMAND	ACTION	COMMAND	ACTION
ROTATING		ZOOMING		FOCUSING	
Hold down the right mouse button and drag the mouse.		Hold down the left and right mouse buttons and drag the mouse forward or backward. OR: If you are using a mouse with a wheel, this can be used to zoom as well.		Select a ship and press the middle mouse button or the [F] key. NOTE: Issuing the focus command a second time will make the camera zoom in as far as possible.	
COMMAND	ACTION	COMMAND	ACTION	COMMAND	ACTION
ALT FOCUSING		CANCEL FOCUS		FLEET VIEW	
To focus on a ship without selecting it, hold down the [ALT] key and leftclick on it.		Press the [C] Key. If you wish to go back to a focus you have cancelled, press the [V] key.		Press the [F1] key. This focuses on all of your ships in the viewable area.	
COMMAND	ACTION				
MOTHERSHIP VIEW					
Press the [HOME] key or press [ALT]+[F] keys.					



3.2 SHIP SELECTION

COMMAND	ACTION	COMMAND	ACTION	COMMAND	ACTION
SELECTING		DRAG SELECTING		SELECTING EVERYTHING	E
Place mouse pointer over desired ship and click the left mouse button to select it. NOTE: If you leftclick on a group of ships in formation, they all will be selected.		Hold down the left mouse button and drag a box around the desired ships.		Press [E] or [CTRL]+[A] to select all of your ships presently on the screen.	
COMMAND	ACTION	COMMAND	ACTION	COMMAND	ACTION
DE-SELECTING	 OR ESC	SHIFT SELECTING	SHIFT + 	HOTKEY GROUPING	CTRL + #
Leftclick on empty space or press the [ESC] key.		To add ships to the selection, hold down [SHIFT] and click the left mouse button on the desired ship(s). It's also possible to hold down [SHIFT] and then drag-select the desired ship(s).		Select the ships you wish to assign a hotkey to and then press [CTRL] + a number key (from 0-9). You may then select that group at anytime, regardless of where you are, simply by pressing its hotkey number. Pressing it again will focus the camera on the ship(s) in that hotkey group.	
COMMAND					
ADDING SHIPS TO A HOTKEY GROUP	Select the hotkey group with its number key and then add the ship or ships to the group as above. Once this is done, reassign the entire group to the hotkey number with the [CTRL]+[0-9] command.				

3.3 THE RIGHTCLICK MENU

At any point during the game, you can get a detailed list of command options specific to a ship or group of ships by rightclicking on one of them while it is selected. This will bring up a menu of command options tailored to that vessel. For instance, rightclicking on a Resource Collector will bring up a menu with the <HARVEST> command on it, while the same rightclick on a group of Fighters will bring up formation options.

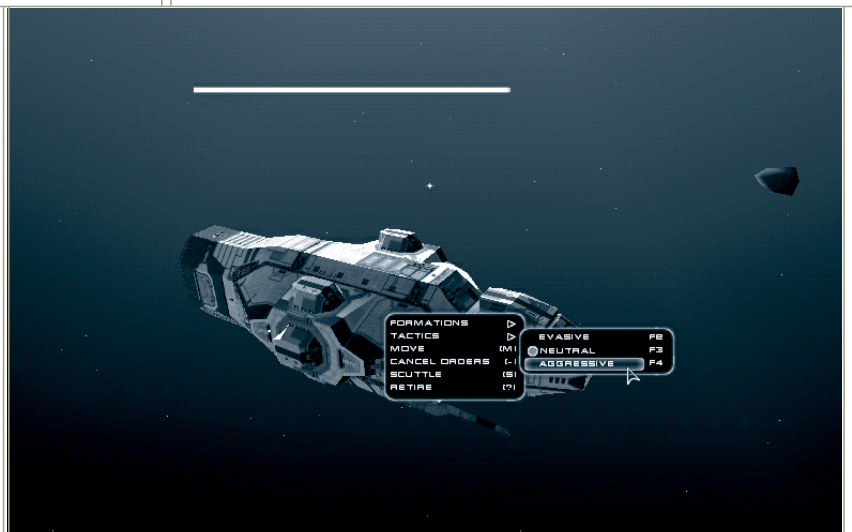



3.4 MOVEMENT

COMMAND

ACTION

HORIZONTAL MOVEMENT

M

Select a ship or group of ships and then press the [M] key. This will bring up the movement disk. Simply move the mouse pointer to where you wish to go and click the left mouse button to issue the move order.

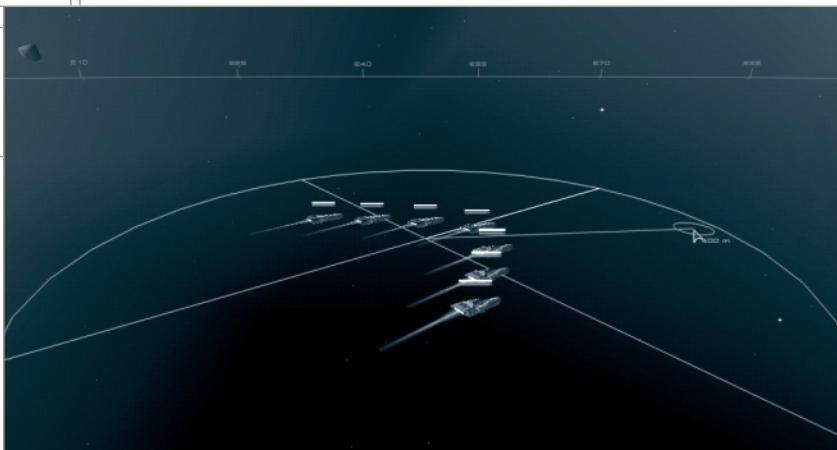

COMMAND

ACTION

3D MOVEMENT

SHIFT

With the movement disk up, hold down [SHIFT] and drag the mouse to add elevation to your destination. As before, clicking the left mouse button will issue the move order.
NOTE: To cancel vertical movement and return to the movement disk to horizontal mode, press [CTRL]+[SHIFT].

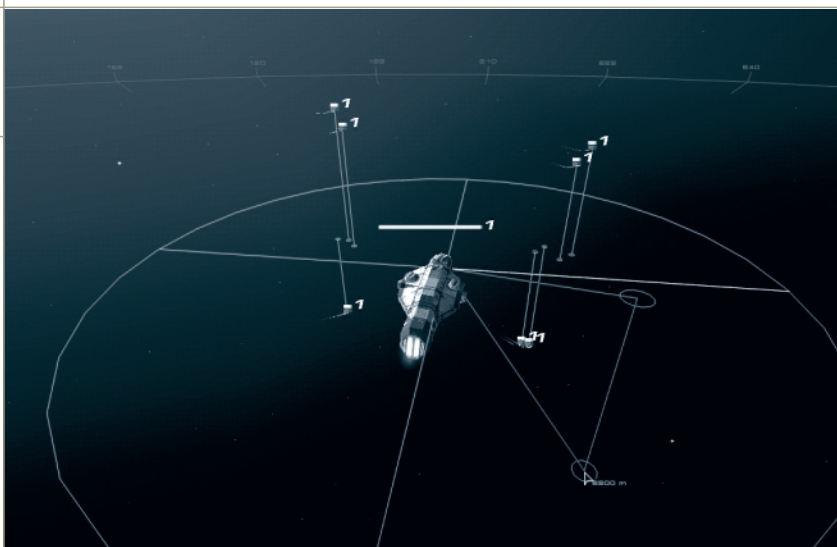

COMMAND

LONG-DISTANCE MOVEMENT

Call up the Sensors Manager using the taskbar or by pressing [SPACE]. Then use the [M] key to bring up the movement disk. You can now move over much longer distances.



3.5 COMBAT

COMMAND	CURSOR ICON	COMMAND	CURSOR ICON	ACTION	COMMAND	CURSOR ICON	ACTION
ATTACKING		GROUP ATTACKING			FORCE ATTACK		
<p>Move the mouse pointer over an enemy ship and click the left mouse button.</p>		<p>Hold down [CTRL] and drag a box around the targets with the left mouse button.</p>		<p>Hold down [CTRL]+[SHIFT] and leftclick on the target. To force an attack on a group of targets, hold down the same keys and drag a box around the targets with the left mouse button.</p> <p>NOTE: Force attacking can be used to attack asteroids and dust clouds as well as your own ships if necessary.</p>			
COMMAND							
MOVING WHILE ATTACKING							
<p>Capital Ships have a special ability to move while keeping their weapons bearing on an enemy ship. To do this, give the Capital Ship its attack order and then give it a movement order. The movement disk will be yellow to signify this mode. When moving in this mode, the line to the destination point will be blue if the destination is still in range of the target or red if the destination is out of range.</p>							
MANAGER SCREENS							
<p>There are several important full-screen interfaces in Homeworld. All can be accessed via the taskbar, or by pressing the appropriate hotkey:</p>							
SENSORS MANAGER				BUILD MANAGER			
RESEARCH MANAGER				LAUNCH MANAGER			

3.6 FORMATIONS AND TACTICS

COMMAND	ACTION									
SETTING FORMATIONS	TAB									
<p>To set a formation, select the desired ships and bring up the rightclick menu. From the <FORMATION> section, you can choose one of seven formations.</p> <p>OR: Formations also can be cycled through by pressing the [TAB] key. [SHIFT]+[TAB] will cycle the formations backward.</p>	<p>OR: Formations can be accessed directly via the F-keys:</p> <table border="1"><tbody><tr><td>F5 Delta</td><td>F9 Wall</td></tr><tr><td>F6 Broad</td><td>F10 Sphere</td></tr><tr><td>F7 X</td><td>F11 Custom</td></tr><tr><td>F8 Claw</td><td></td></tr></tbody></table>	F5 Delta	F9 Wall	F6 Broad	F10 Sphere	F7 X	F11 Custom	F8 Claw		
F5 Delta	F9 Wall									
F6 Broad	F10 Sphere									
F7 X	F11 Custom									
F8 Claw										
COMMAND	ACTION	COMMAND								
CUSTOM FORMATION	F11	MILITARY PARADE FORMATION								
<p>Custom formation lets you create your own formations. To create a custom formation, move your ships into the desired position, select them all, then select <CUSTOM> from the rightclick menu or press [F11].</p>		<p>When you build ships, they come out of your Mothership or Carrier and go into Military Parade formation with that ship. If at any time you want to put ships back into Military Parade formation, select them and the Mothership, then press [TAB] or any of the formation function keys [F5] - [F11].</p>								

FORMATION DESCRIPTIONS

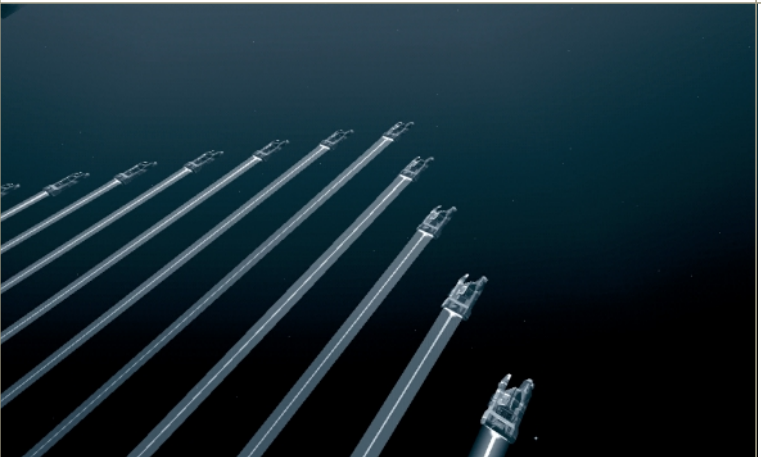
FORMATION		
DELTA	F5	
<p>The standard flat triangle formation is an excellent way of organizing groups of Strike Craft into effective squadrons, but it lacks the flexibility and firepower concentration available to the more three-dimensional formations.</p>		

FORMATION DESCRIPTIONS

FORMATION

BROAD

F6

This flattened line is not effective for Strike Craft as it disperses their firepower. It is more useful for squadrons of Capital Ships, where unit quick identification and selection are as important as firepower. It is useful formation to approach in if you are planning to break ships off to strike at specific targets once the battle is joined.

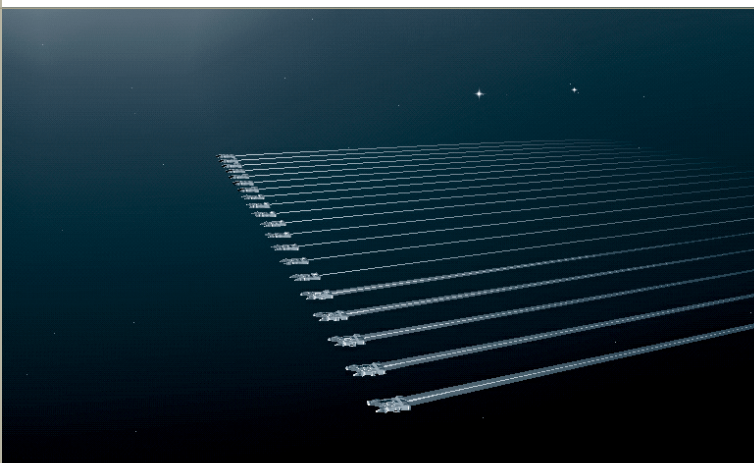

FORMATION

X

F7

The flying X formation is an excellent Strike Craft formation, concentrating a large number of vessels into a relatively small three-dimensional space. Its only drawback is that the dense formation makes individual ships vulnerable to slow turret fire they might otherwise have avoided if they were dispersed.

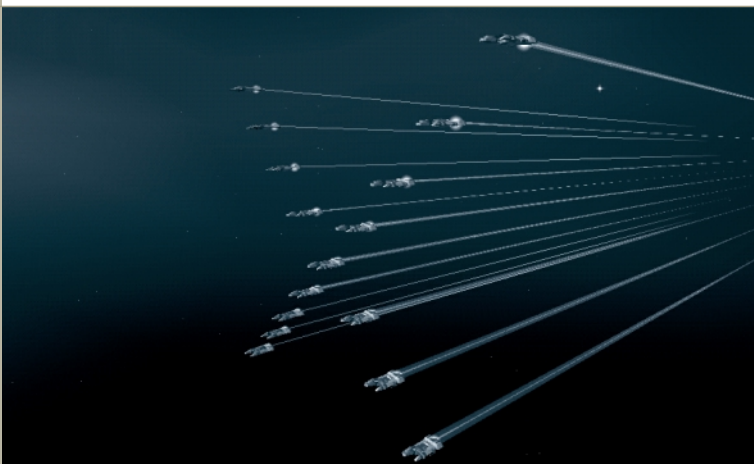

FORMATION

CLAW

F8

Like its natural namesake, this formation is deadly when striking out at an individual target. The claw is a superb formation for Strike Craft when they are targeting a Capital Ship. The four curving lines of Fighters make concentrating firepower and envelopment deadly efficient. The only drawback is identifying and selecting single ships inside this complex formation.

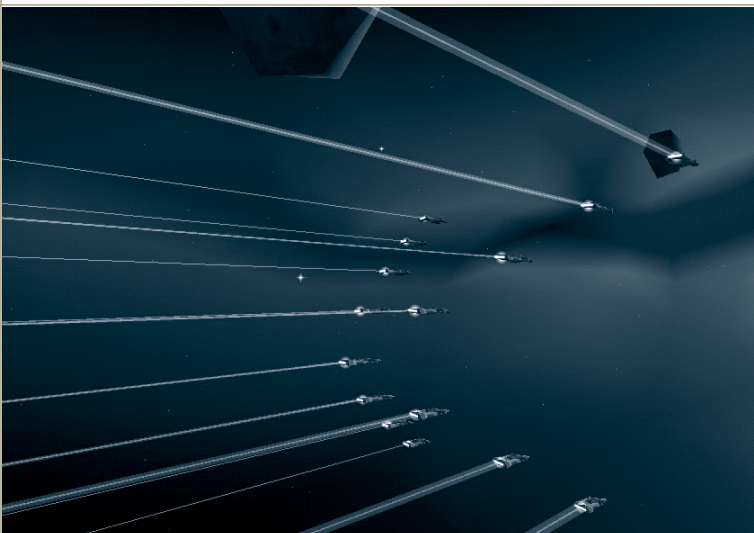



FORMATION DESCRIPTIONS

FORMATION

WALL

F9

Most effective for Capital Ships, the wall formation allows larger vessels to concentrate firepower without dangerously crowding each other. The wall is not a subtle formation but does give large groups of big ships an effective attack mode.



FORMATION

SPHERE

F10

This is the deadliest of all formations in terms of continuous firepower. Ships in this formation lose their ability to perform complex flight maneuvers but gain the ability to constantly fire at targets from every angle. This is also an effective guarding formation as it puts the vessel to be protected in the center of the sphere.

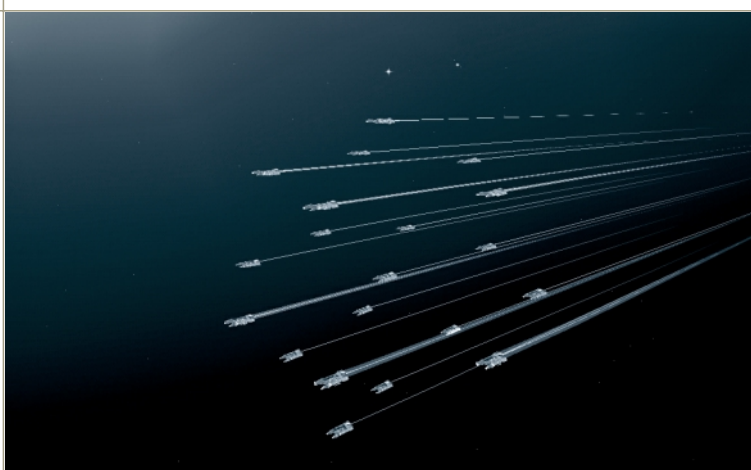

3.6 FORMATIONS AND TACTICS (CONT'D)

COMMAND

SETTING TACTICS

To change the tactics setting, select the desired ships and bring up the rightclick menu. From the <TACTICS> section you can choose one of three settings: Evasive, Neutral or Aggressive.

The tactics setting can be increased using the] key and decreased using the [key.

OR: Tactics can be accessed directly via the F-keys:

F2 Evasive

F3 Neutral

F4 Aggressive

TACTIC DESCRIPTIONS

TACTIC

EVASIVE

F2

Evasive tactics are best used when resources are tight and each ship is vital. Your ships won't hit as hard, but they are more likely to come home. Ships set to Evasive will boost power to engines in order to increase speed and maneuverability. This will come at the cost of lowered power to weapons and a slight increase in fuel consumption for Strike Craft (Fighters and Corvettes). When attacking, Fighter groups also will break up into flight pairs, where one ship will take point and the other will serve as wingman and take measures to remove threats that lock onto the lead vessel.

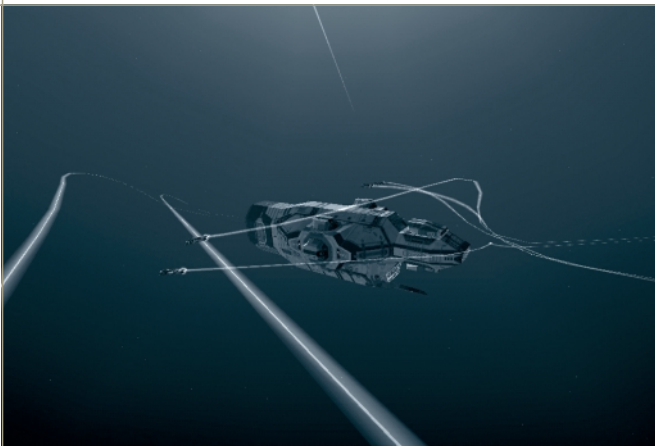



TACTIC DESCRIPTIONS

TACTIC

NEUTRAL

F3

This is the normal stance for ships. Strike Craft set to neutral will perform evasive maneuvers while attacking enemy ships. If no orders are issued and enemies are nearby, ships in neutral will fire from their current position, but will not engage in full combat.



TACTIC

AGGRESSIVE

F4

Ships in Aggressive mode are out for blood and will attempt to destroy the enemy even at the cost of their own lives. Use this tactical stance if resources are not a factor or if you need to hurt your opponent as hard and as quickly as possible. Strike Craft in this mode shunt power from the engines into the weapons grid, so speed and agility are reduced but firepower is increased. Ships in Aggressive tactics will not perform any kind of evasive maneuvers and also will attack nearby enemies without being issued orders. Resource Collectors in Aggressive tactics will continue to harvest even if under attack.

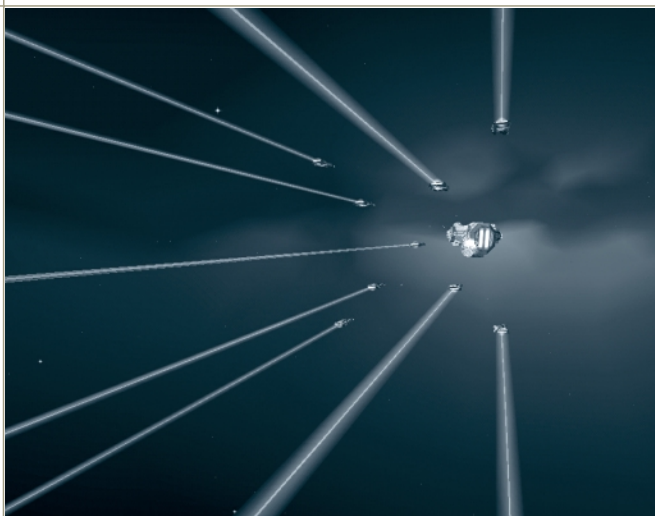









3.7 OTHER COMMANDS

COMMAND	ACTION	COMMAND	ACTION	COMMAND	ACTION
HARVESTING		DOCKING		SUPPORTING	
<p>Select a Resource Collector, move the mouse pointer over any resource and click the left mouse button.</p> <p>OR: Bring up the rightclick menu and select the <HARVEST> command. This will cause the Resource Collector to begin harvesting the nearest resource.</p> <p>OR: Press the [H] key. This will also make the Resource Collector find the nearest resource.</p>		<p>Select the desired ship(s) and then doubleclick on the vessel you wish to dock with (it must have docking capabilities).</p> <p>OR: bring up the rightclick menu and select the <DOCK> command. This will cause the selected ship(s) to dock with the nearest capable vessel.</p> <p>OR: Press the [D] key. This will instruct your ships to dock with the nearest capable vessel.</p>		<p>Select the support ship, then hold down the [Z] key and leftclick on the Fighters or Corvettes to service.</p>	
COMMAND	ACTION	COMMAND	ACTION		
GUARDING		SPECIAL OPERATIONS			
<p>Hold down both [CTRL] + [ALT] and then leftclick on the ship you wish to guard.</p> <p>OR: Hold down the [G] key and click the left mouse button on the ship you wish to guard.</p>		<p>If a ship has a special function, you can activate it by pressing the [Z] key. If the special function has to be performed on another vessel, hold down the [Z] key and then click the left mouse button while the cursor is over the target vessel.</p>			

SHIP	SPECIAL OPERATION	SHIP	SPECIAL OPERATION
Scout	Speed Burst	Missile Destroyer	Missile Volley Attack
Cloaked Fighter	Cloaking	Carrier	Can repair & refuel Strike Craft
Heavy Corvette	Charged Burst Attack	Resource Collector	Can refuel Strike Craft
Salvage Corvette	Captures enemy ships	Resource Controller	Can refuel Strike Craft
Minelayer Corvette	Creates minefields	Cloak Generator	Cloaking
Support Frigate	Can repair & refuel Strike Craft	GravWell Generator	Captures Strike Craft
Drone Frigate	Drone launching/retraction	Defense Field Frigate	Defense Field (always on)



3.8 MISCELLANEOUS COMMANDS

COMMAND	ACTION	COMMAND	CURSOR ICON	COMMAND	ACTION
CANCEL ORDERS		SALVAGE		RETIRE	
<p>Select the desired ship(s), bring up the rightclick menu and select the <CANCEL ORDERS> command.</p> <p>OR: Select the desired ship(s) and press the [~] key.</p>		<p>Select a Salvage Corvette, then leftclick on the ship to be salvaged.</p> <p>OR: Hold down the [Z] key and leftclick on the ship to be salvaged.</p> <p>OR: Hold down [Z] and drag a box around the target with the left mouse button.</p>		<p>Bring up the rightclick menu and select the Retire command. Ships given the Retire order will return to the nearest Mothership or Carrier and be scrapped. A percentage of the construction cost (in RUs) will be recovered.</p> <p>OR: Press the [I] key once you have selected the ship(s) you wish to retire.</p>	
COMMAND	ACTION	COMMAND	ACTION	COMMAND	ACTION
KAMIKAZE		HYPERSPACE JUMP		TACTICAL OVERLAY	
<p>After giving a ship normal attack orders press the [K] key. Only Strike Craft can kamikaze.</p>		<p>This multiplayer-only command allows Capital Ships to perform hyperspace jumps. Just select the ships you wish to hyperspace, bring up the rightclick menu and select the <HYPERSPACE> command. The Sensors Manager and movement disk will be brought up automatically. Leftclick to set the hyperspace destination. The cost of the hyperspace jump will be displayed near your cursor. If this cost turns red, you don't have enough Resource Units to make the jump.</p>		<p>Press the [CAPS LOCK] key.</p>	
COMMAND	ACTION			COMMAND	ACTION
PAUSE		SCUTTLE			
<p>Press the [P] key at any time during gameplay to pause the game.</p> <p>NOTE: The camera is still fully active (including focusing) while the game is paused, but no game commands can be issued.</p>		<p>Bring up the rightclick menu and select the Scuttle command.</p> <p>OR: Press the [S] key once you have selected the ship(s) you wish to self-destruct.</p> <p>NOTE: You must issue the scuttle command twice to confirm this unusual order.</p>			



3.9 MULTIPLAYER CONTROLS

A small number of commands are active only during multiplayer battles. These are used to interact with other players:

COMMAND		COMMAND	COMMAND
SENDING A CHAT MESSAGE		SENDING A PRIVATE CHAT MESSAGE	FORMING ALLIANCES
Press [T] and then type in your message. Press [RETURN] when done.		Press [T] and then type [/<playername>] to specify who to send it to. After typing a few letters, the computer will automatically finish the name for you.	Turn on the Tactical Overlay [CAPS LOCK] and then click the right mouse button on the name of the player you wish to ally with. Select <FORM ALLIANCE> from the menu that appears.
COMMAND		COMMAND	
BREAKING ALLIANCES		TRANSFERRING RUs	
Turn on the Tactical Overlay, rightclick on the player's name you wish to end your alliance with and choose <BREAK ALLIANCE> from the menu.		Turn on the Tactical Overlay, rightclick on the player you wish to send Resource Units and choose <TRANSFER RESOURCES> from the menu. After this is done a prompt will appear at the top of the screen. Type in the number of RUs to transfer and press [ENTER].	

3.10 TECHNOLOGY TREE

MULTIPLAYER

Homeworld uses a research tree system in which basic technologies can lead to more advanced breakthroughs. Most ships require at least one or more technologies in order to be built. The following section will describe each technology to be found in Homeworld, as well as listing the discoveries required to reach that branch and the new technologies it might suggest.

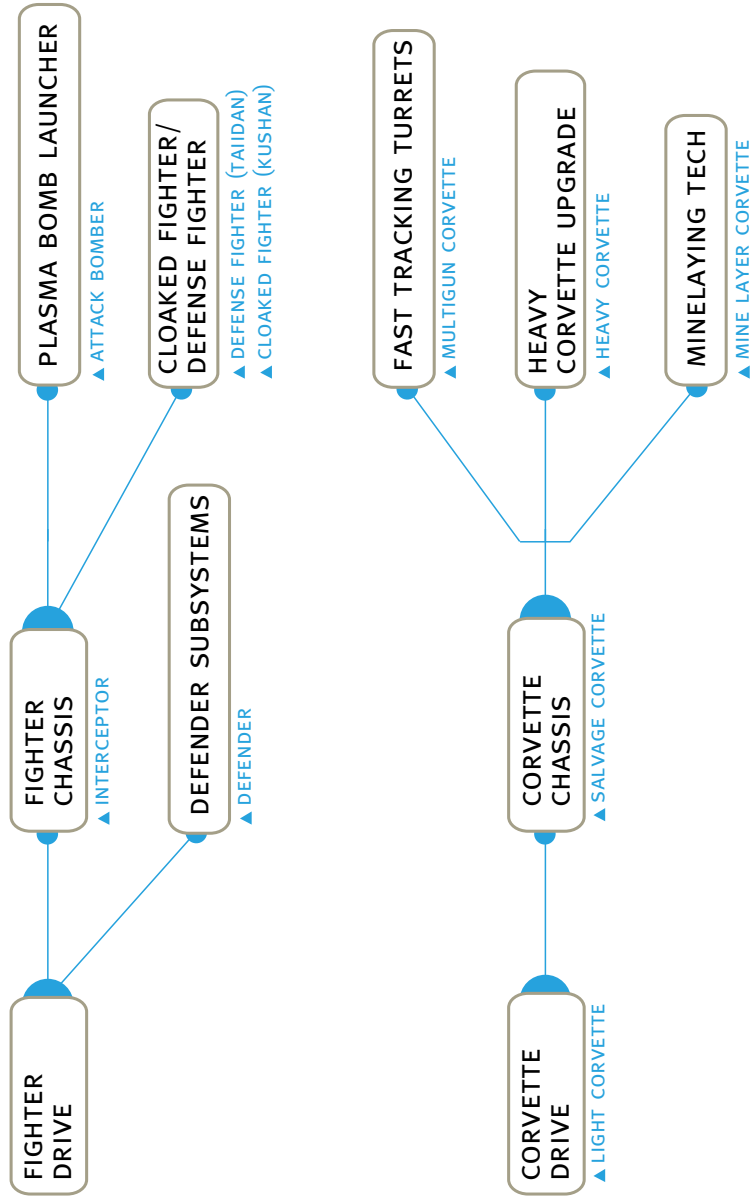

TECHNOLOGY TREE LEGEND	
ICON	DESCRIPTION
	Technology
	Ships Produced
	Technology Description



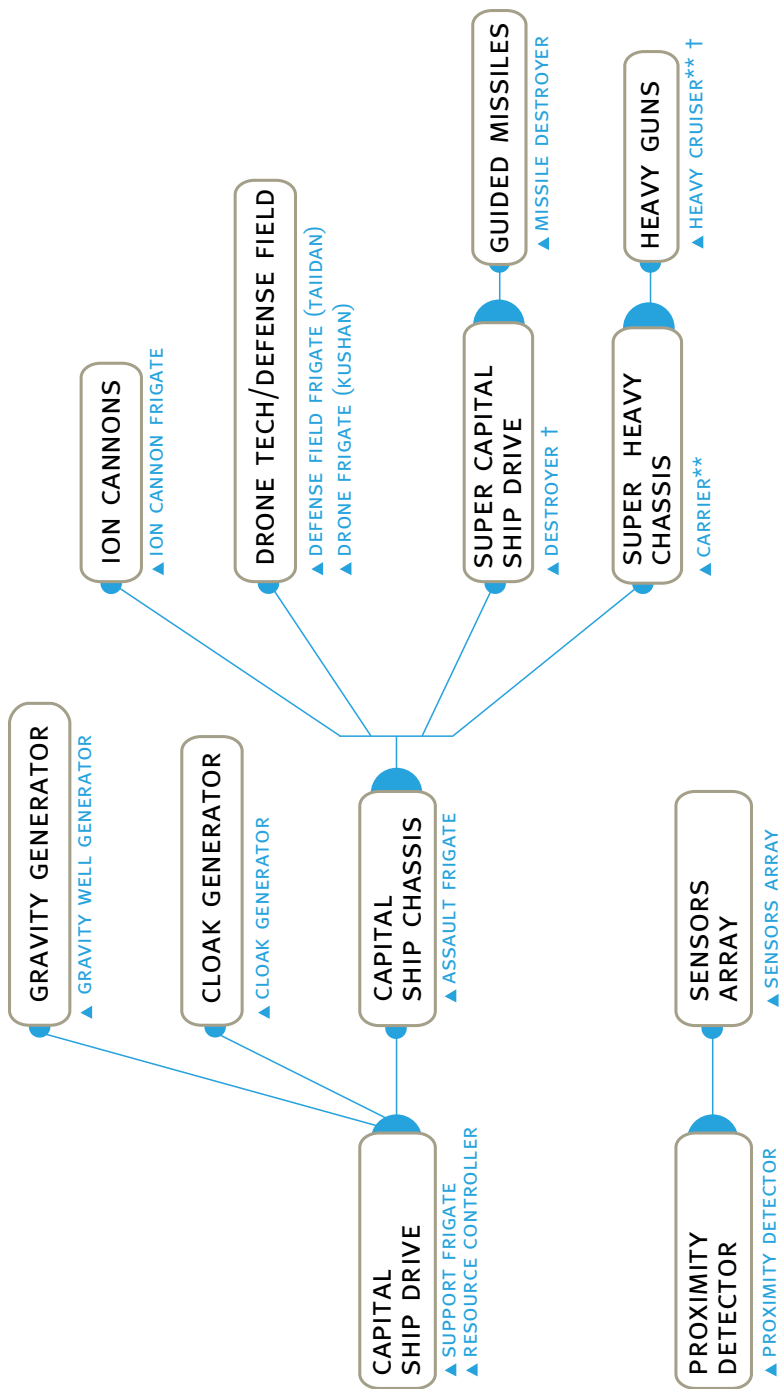

** ALSO REQUIRES SUPER CAPITAL SHIP DRIVE

† ALSO REQUIRES ION CANNONS

TECHNOLOGY TREE LEGEND	
ICON	DESCRIPTION
TECHNOLOGY	Technology
▲	Ship Produced
■	Technology Description

4.1 INTERFACE OVERLAYS

screen shot

The gameplay screen has numerous overlays that convey information to the player about ships in text and graphic form.

Taskbar: When the mouse pointer touches the bottom of the screen, the taskbar will appear. It contains a set of buttons for the Managers, a display for the current health of your Mothership, your current amount of Resource Units, and a Fleet Intelligence box that will display mission objectives in single player games. This taskbar can be toggled to be permanently visible from the gameplay options menu.

Cursor Text: When the cursor is on top of a ship, its type will be displayed on the bottom left-hand corner of the screen.

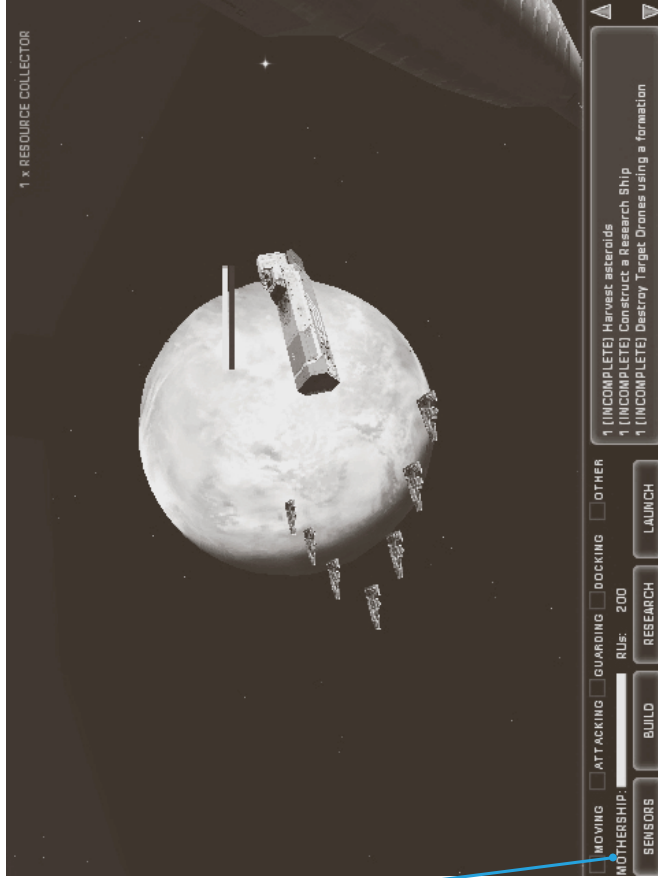

Tactical Overlay: If you turn on the tactical overlay with the [CAPS LOCK] key, a series of graphic symbols will be overlaid on units that are too distant from your camera view to make out clearly. A symbol legend will appear in the upper left hand corner of the screen. In multiplayer mode, a list of players will also be displayed. Alliance and resource transfer options can be accessed by right clicking on any of the names on the list.

Info Overlay: On the top right-hand corner of the screen is a list of currently selected ships and the number of each type if you have selected a group of ships. You can leftclick on a ship type from that list in order to select one group of vessels from a group of many different types.

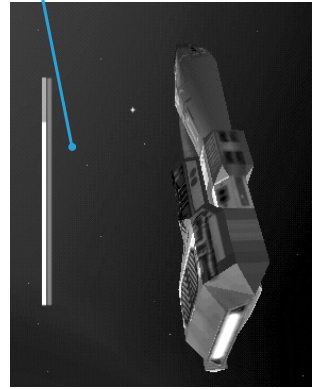

Ship Selection Overlay:

When you select a ship, a green health bar overlay will appear above the ship indicating how much damage the vessel has incurred. The bar will shorten as the ship is damaged and will change from green to yellow to red as conditions worsen.

Strike Craft (Fighters and Corvettes) require fuel, so they also have a blue fuel bar overlay when they are selected. The length of this bar indicates how much fuel the Strike Craft has left. Certain ships use a brown bar in addition to the green

health bar. For the Resource Collector, this indicates how much of its resource capacity is used. For the Cloak Generator and Gravity Well Generator, this indicates how much energy is left to maintain the cloaking or gravity field.

4.2 MANAGER SCREENS

Many of the more complex tasks, like ship building and research, have their own special screens to help you manage them more effectively and keep track of the strategic considerations of battle. They can be accessed at any time or place during combat by hitting the appropriate command key, and you can return to tactical view by hitting the [ESC] key.

4.2.1 BUILD MANAGER

screen_shot

To access the build manager, do one of the following:

- Doubleclick on the Mothership or Carrier from which you wish to build.
- Select the ship you wish to build.
- Bring up the rightclick menu and then select the <build> command.
- Bring up the taskbar at the bottom of the screen and leftclick on the build button.
- Press the [B] key.

The build manager allows you to build ships and set up the construction queue in order to build many units at once.

The build manager gives basic details of each type of ship presently available for construction as well as your current number of resource units.

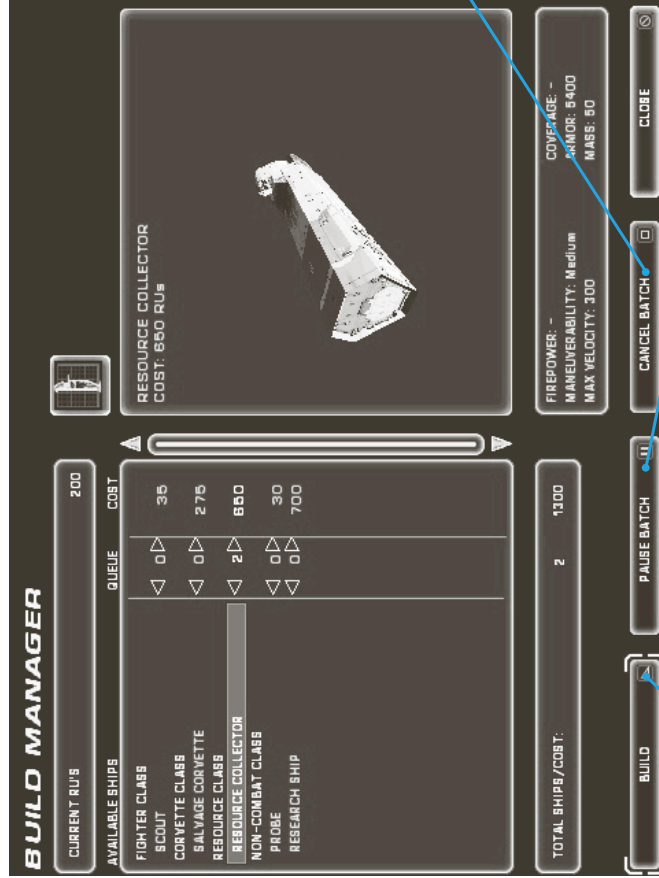

Build Progress:

At this point, two colored bars will appear above the listing for the ship type you have just ordered built. The top line shows how close to completion a single vessel is, while the lower bar shows how close to completion the entire build order is. If you only ordered one vessel built, these two bars will move along together.

Canceling a Build

To cancel a build, leftclick on the type of ship being built and then leftclick on the <CANCEL BATCH> button. The RUs used in construction will be reclaimed.

Building:

All the ships your current tech levels allow you to build are listed in the left side panel. Leftclick on the desired vessel with the left mouse button and its image and basic performance details will appear in the right side window. Leftclick again to add units to the production queue. When you are done adding units, leftclick on the <BUILD> button.

Pausing a Build:

To pause a build, leftclick on its progress bar and then leftclick on the <PAUSE BATCH> button. When you are ready for the project to resume, simply re-select the ship type and then leftclick on the <PAUSE BATCH> button again. Construction will resume exactly where it left off.



In order to access the research manager, do one of the following:

- Doubleclick on your Research Ship.
- Select the Research Ship, bring up the rightclick menu, and select the <RESEARCH> command.
- Bring up the taskbar at the bottom of the screen and leftclick on the research button.
- Press the [R] key.

Technology List:

This panel contains a list of technologies you can currently research. When a technology has been selected, a brief description of it and a graphic appear in the right-hand side panel. Technologies that have already been successfully researched will appear on the list with a green dot beside them.

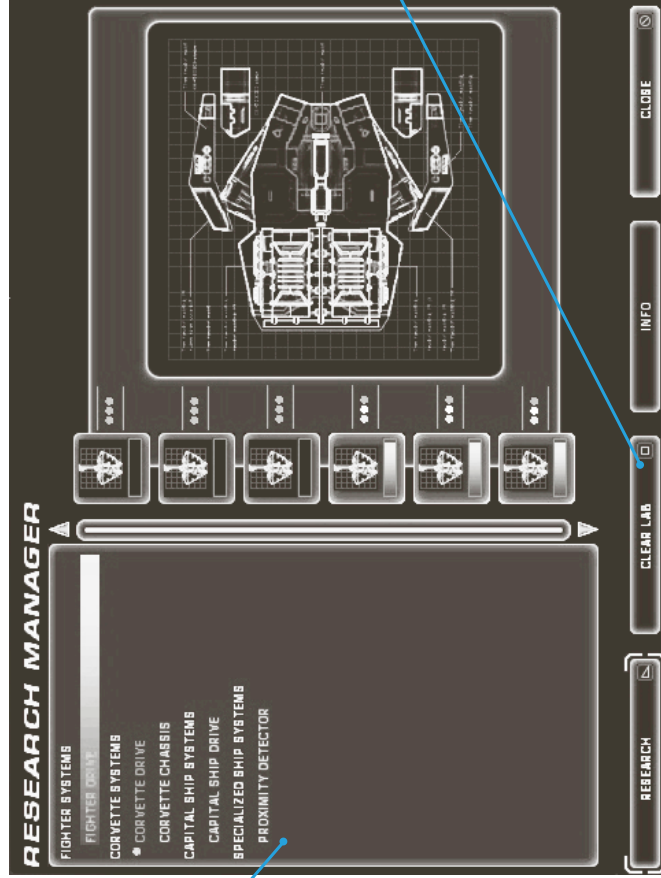

Researching a Technology:
Doubleclick on the technology you wish to research.

NOTE: If you want to use multiple lab ships, select them first, then doubleclick on the technology.

OR: Leftclick on the <RESEARCH> button.

Canceling Research:

Select the technology currently being researched from the left panel list and leftclick on the <CLEAR LAB> button found along the bottom of the manager. You can also halt research in a particular lab ship by selecting it from the icon strip along the upper right side of the manager and then leftclicking on the <CLEAR LAB> button. When a project is canceled, all accumulated research in it is lost.

4.2.3 SENSORS MANAGER

screen_shot

In order to access the sensors manager, do one of the following:

- (a) Bring up the taskbar at the bottom of the screen and leftclick on the sensor button.
- (b) Press the [SPACEBAR]

The sensors manager gives you a general view of the entire battlespace, and a detailed view of the space surrounding any of your vessels. Detailed areas exist within the blue spheres, and represent where your scanners are giving accurate information on what lies in the region. The black areas represent space outside of your scanning range, and so they are without detail.

Note: The normal camera commands of rotate and zoom are still fully functional in the sensors manager.

Using The Tactical Overlay:

Leftclick on the <TACTICAL OVERLAY> button along the bottom edge of the manager. With this button activated, the Tactical Overlay symbols from the normal gameplay screen will appear for Resource Collectors and Capital Ships.

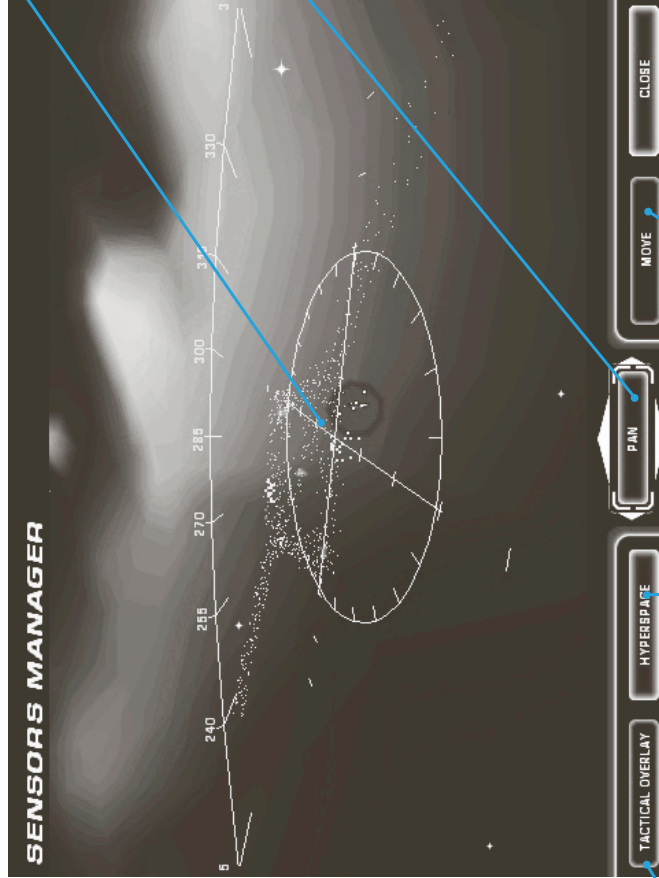

Looking:

Leftclick on any ships in the blue area to leave the Sensors Manager and go to that location.

OR: Drag a small box around the ships you wish to go to using the left mouse button.

Panning:

A 2-D disk has been provided to give a frame of reference for direction and distance. Use the crosshair in the middle of it to get a better look at different parts of the battlespace. Leftclick on the <PAN> button. While holding the button, drag the mouse around. When you've centered the crosshair on the area you want to look at, release the mouse button, and the normal camera controls are active again.

Hyperspace:

This command allows Capital ships to perform hyperspace jumps. With some Capital ships selected, click on this button to bring up the movement disk. Leftclick to set the destination you wish to hyperspace to. The cost of the hyperspace jump will be displayed near your cursor. If this cost turns red, you don't have enough Resource Units to make the jump.

Moving Ships:

Press the [M] key or leftclick on the <MOVE> button, and then issue movement commands as you would from the normal gameplay screen. This is very useful for moving ships across long distances.

SENSORS MANAGER LEGEND:

ITEM:	INDICATES:
GREEN DOTS	YOUR SHIPS
FLASHING GREEN DOTS	SELECTED SHIPS
RED DOTS	ENEMY SHIPS
YELLOW DOTS	ALLIES
BROWN DOTS	ASTEROIDS
FUZZY BROWN DOTS	DUST CLOUDS
RED 'PINGS'	SHOW WHERE BATTLES ARE TAKING PLACE AND WHERE PROXIMITY DETECTORS HAVE FOUND ENEMY SHIPS
GREEN 'PINGS'	SHOW WHERE NEWLY-BUILT SHIPS ARE LOCATED
YELLOW 'PINGS'	SHOW WHERE ANOMALIES ARE LOCATED (SINGLE PLAYER ONLY)

To Access the Launch Manager:

- Select the ship you wish to launch from, bring up the rightclick menu and select the <LAUNCH> command.
- Bring up the taskbar at the bottom of the screen and leftclick on the sensor button.
- Press the [L] key.

The launch manager allows you to check which ships are currently docked and set automatic launch parameters. The list of docked ships is in the left panel with a visual display of a selected ship type visible in the right-hand panel. The icons in a row above the right panel represent your Mothership and any Carriers you may have.

Launching Ships:

Leftclick on the type of ship you wish to launch and then leftclick on the <LAUNCH> button along the bottom of the screen. If you want to select multiple ship types for simultaneous launch, hold down the [CTRL] key or the [SHIFT] key while you select ship types.

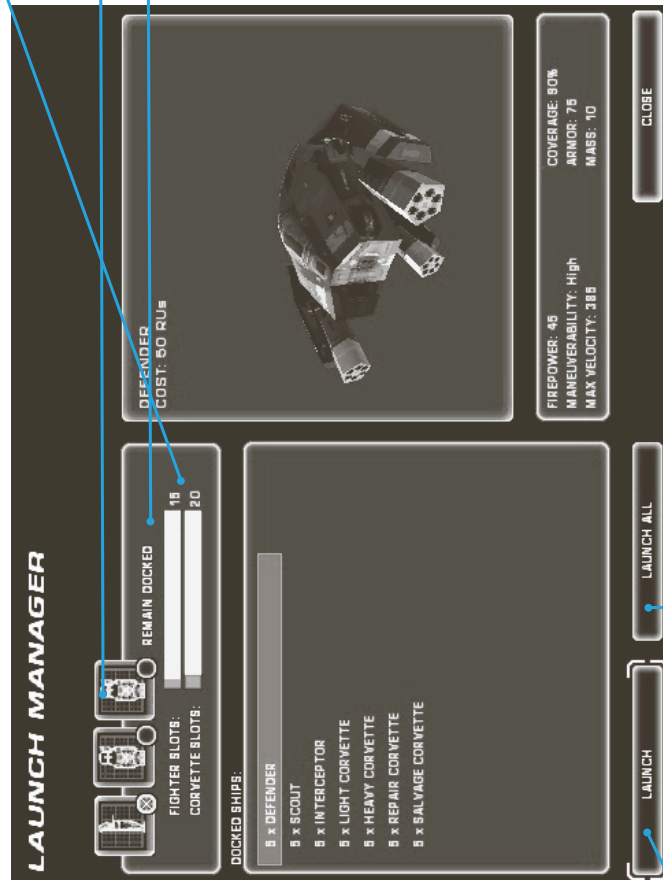

Docking Capacity:

These two colored bars graphically represent the remaining capacity of the ship in green. The actual numbers of Fighters and Corvettes docked are given to the left of their respective bars.

Selecting the Launch Vessel:

If you have built any Carriers, their icons will appear here. To see which ships are docked in one these vessels, leftclick on its icon from this list.

Remain Docked:

Leftclick on this checkbox to keep Strike Craft inside a Mothership or Carrier when they dock.

Launching Everything:

To launch all ships held in the bay leftclick on the <LAUNCH ALL> button.

5 SINGLE PLAYER

screen_shot

5.1 Starting a Game

In order to start a new single player game, leftclick on the <SINGLE PLAYER> button in the Main Menu.

Choosing Your Fleet:

Leftclick on the <KUSHAN> or <TAIIDAN> button to choose which fleet to play. A sample ship appears in the window in order to show the currently selected color scheme.

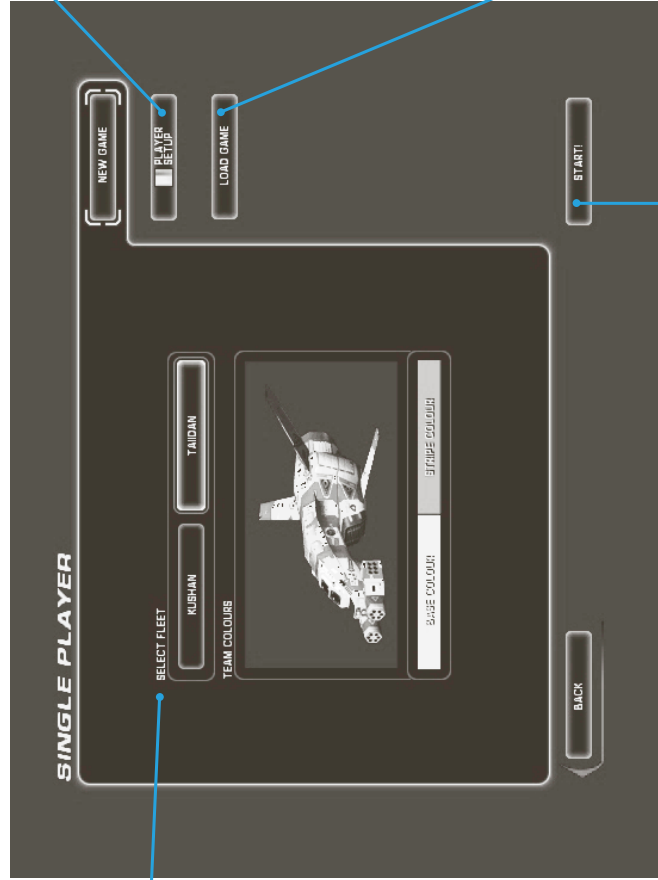

Player Setup :

This screen lets you set the base and stripe colors of your ships. To change your base color, leftclick on the <BASE COLOR> button. A small white circle will appear inside the large rainbow box. Click and drag the circle around the rainbow box until you have achieved a shade you are satisfied with. To change the stripe color, simply leftclick on the <STRIPE COLOR> button and repeat the process of dragging the white circle to choose a stripe color. You can also drag the slider, located to the right of the rainbow box, up and down to adjust the brightness of the color.

Loading a Saved Game:

Leftclick on the <LOAD GAME> button. A screen will appear with a list of saved games. Homeworld automatically saves your campaign at the beginning of every new level. These auto-saved games will appear along with the ones you have saved yourself. To load one, leftclick on it and then leftclick on the <LOAD!> button.

Save a Game:

At anytime during gameplay, hit the [ESC] key and then choose <SAVE GAME> from the menu. When the Save Game screen comes up, leftclick in the narrow box below the save game list and type in a name for the saved game. Then leftclick on the <SAVE> button.

Starting The Game:

When you are happy with your choice of fleet and ship color, leftclick on the <START!> game button to begin the Single Player campaign.

5.2 CHARACTERS

screen shot

The two characters you will hear from most often in Homeworld are Fleet Command and Fleet Intelligence. Anytime a character speaks, subtitles will appear at the top of the screen next to the icon.

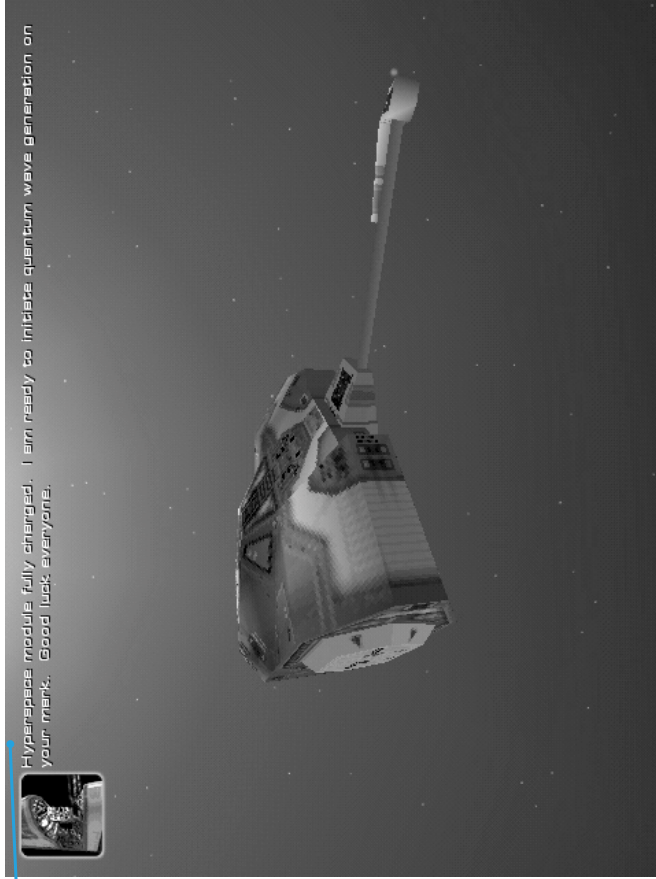

5.3 MISSION OBJECTIVES

screen shot

Mission objectives in the single player game are displayed on the right side of the taskbar. You can leftclick on an objective to replay the speech event that describes it. Primary objectives must be completed for the mission to end, but secondary objectives are optional.



6 MULTIPLAYER

screen shot

Homeworld can be played against human and computer opponents through a variety of different modes. While there are three different ways to engage in a multiplayer game of Homeworld, they all use the same system for creating the actual game and setting up the gameplay options and rules.

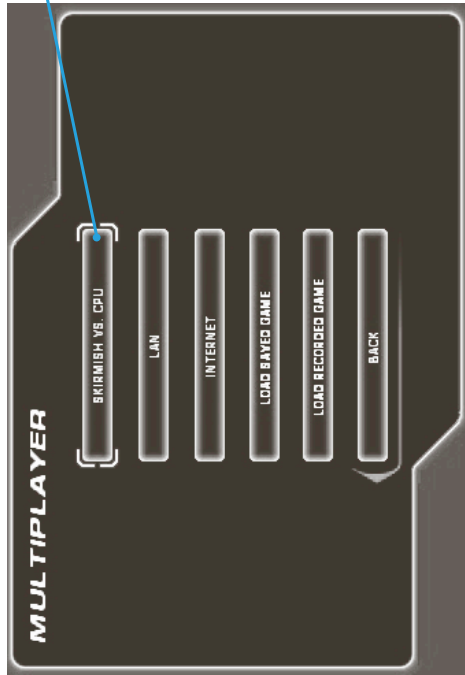

6.1 Skirmish vs. CPU

This option is for playing multiplayer games against computer players. After a game is created with the desired gameplay options (see “Setting Multiplayer Game Options”), leftclick on the <START> button to begin the action.

6.2 LAN

screen shot

To play Homeworld on a Local Area Network, choose <LAN> from the multiplayer menu.



6.2.1 Play Lan Game

On this screen, leftclick on the name field and type in the name you wish to be known by on the multiplayer battlefield. Hit <ENTER> when you are finished typing. Leftclick on the <PLAYER SETUP> if you need to change your race or ship colors from previous multiplayer sessions. Once you are satisfied, leftclick on the <GO!> button.

People who want to play together on a LAN must be using the same protocol.

The lobby is where you go to see who else is on the LAN, chat, organize your own game, or see what games are still accepting players. The names of the players currently in the lobby are in the bottom right panel, and any chat messages are printed in the bottom left panel.

Chatting:

If you wish to send messages to the other players in the lobby, just leftclick here and type your message. If you wish to whisper a private message to just one player, type /<playername> and the rest of your message.

Creating Your Own Game:
Leftclick on the Create Game button. This takes you to the game setup screen.

Game Details:

The list of games available in the lobby is displayed in the large upper display panel. To see which options are being used in a game, leftclick on the game you are interested in and then leftclick on this button.

Joining a Game:

Leftclick on the game you wish to join on the main list and then leftclick on this button.

Player Setup:

If you wish to change your fleet or ship colors at any time, leftclick on this button.

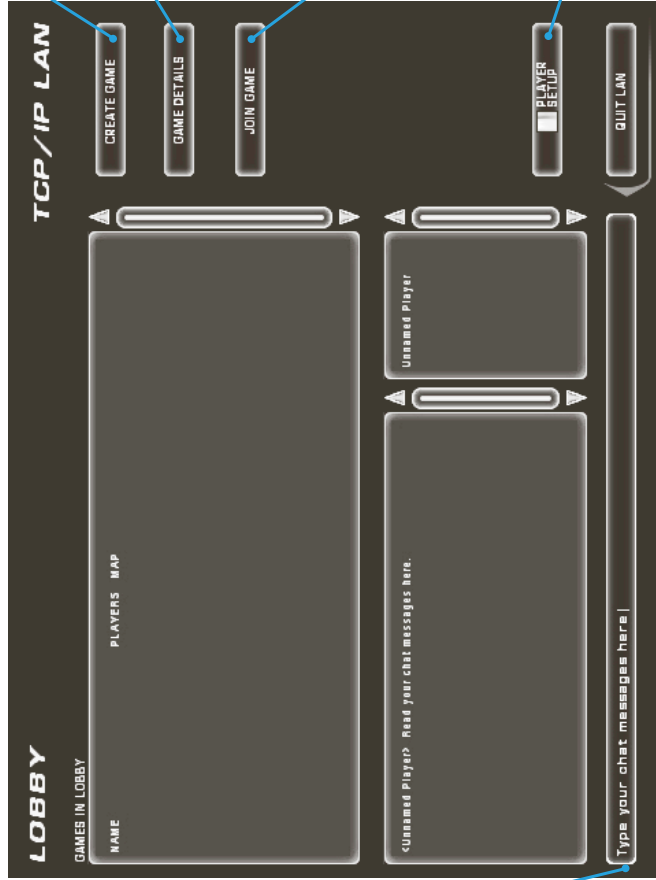

6.2.3 SETUP GAME

screen_shot

Setup Game:

The setup game screen is where you set the name of your game and the number of CPU players, as well as all the gameplay options available.

Start With:

This setting lets you decide whether to start the game with a Mothership or a Carrier.

Naming Your Game:

Click on this panel and type in a name for your game.

Number of CPU Players:

Leftclick on the arrows to increase or decrease the number of computer players you want in the game.

CPU Difficulty:

This slider lets you set the difficulty of the computer-controlled opponents.

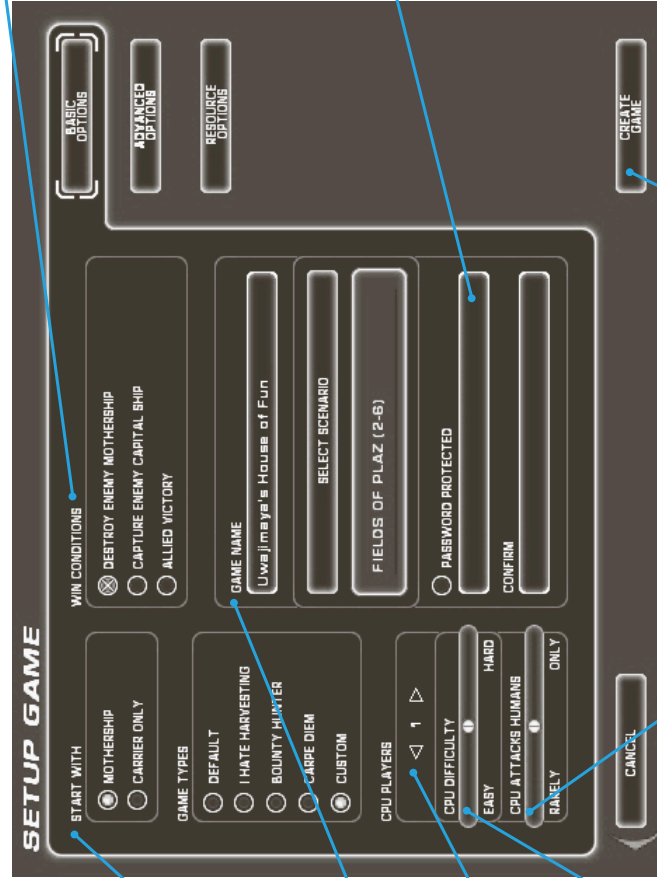

Win Conditions:

These checkboxes let you set the various win conditions for the game. Destroy enemy Mothership means the enemy's Mothership must be destroyed and capture enemy capital ship means you can also win by capturing an enemy capital ship. Allied victory means that players who are allied can win the game together by defeating their enemies.

Password on the Game:

If you want to restrict access to your game, leftclick on the <password protected> checkbox. Leftclick on the narrow panel directly below and type in the password you wish to use. Confirm your password by re-entering it in the panel below. In order for other players to join the game you created, you will have to tell them the password.

Create Game:

The rest of the game options are explained below in the "setting, multiplayer game options" section. When you are satisfied with your choices, leftclick on the <CREATE GAME> button.

CPU Attacks Humans:

This sliders lets you set how likely the CPU player will attack human opponents.

After you create the game, you are returned to the lobby to wait for players to join your game. When you are ready to start, you can leftclick on the <START GAME> button. If you wish to change some of the game options, click on the <SETUP GAME> button and this will take you back to the game options screen. If you no longer wish to host a game, leftclick on the <DISSOLVE GAME> button.

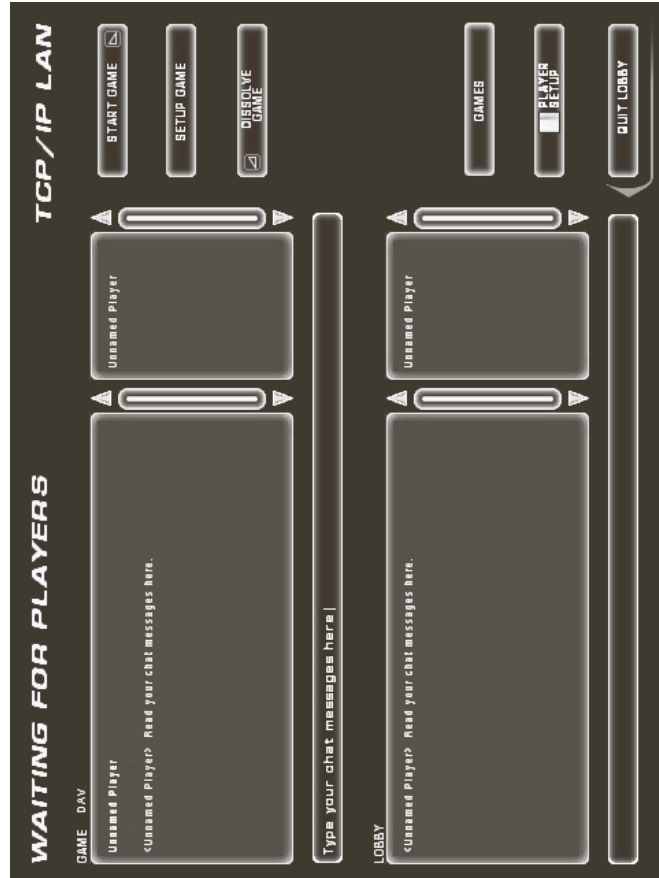

6.3 INTERNET

Homeworld can be played over the Internet only on the World Opponent Network, a free gaming site. If you do not already have an account, you must create one before playing Homeworld.

6.3.1 LOGIN

screen shot

From this screen you can log onto WON, change your colors or fleet, change your password, or create a new account.

Launch WON!:

To connect to the World Opponent Network, leftclick on this button and you will find yourself in the Homeworld lobby on WON. Setting up and playing a game on WON is identical to playing on a LAN except WON has multiple rooms instead of just one lobby.

Firewall Settings:

If you are behind a firewall, you should select the <Behind Firewall> button. If you know you're not behind a firewall you should check the <Not Behind Firewall> button. If you are unsure or don't know what a firewall is, choose Auto-detect, which is the default.

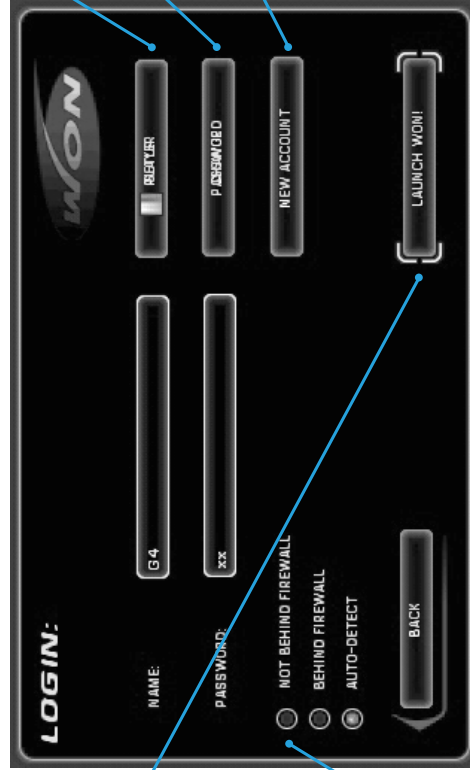

Player Setup:

Leftclick on this button if you wish to change your fleet or ship colors.

Change Password:

If you wish to change your WON password, leftclick on this button.

Create New Account:

If you do not have a WON account, leftclick on this button, then type in the following information:

Name

Leftclick on this panel and type in the name you wish to use for your WON account.

Password

Leftclick on this panel and enter the password you wish to use.

Confirm Password

Leftclick on this panel and enter your password again to make sure you have typed it in correctly in the previous panel.

New Account

Leftclick on this button to create a new account. If you chose an account name already in use you will have to repeat this process using a different account name.

Remember, if you are unsure what your firewall status is, just select auto-detect.

Technical note: When you create a game, if one or more players are behind a firewall, WON will create a dedicated server for the game instead of using the default peer-to-peer connection. Slow modem users *who host games* may want to choose the <Behind Firewall> option (even if they are not behind a firewall) so WON always uses a dedicated server, which will require less bandwidth on their modem.



WON is organized into rooms. Players can leave and enter rooms and create or join games in the current room. Players in the current room are listed in the panel on the right, and chat messages are listed in the panel on the left. The names of the players in the lobby are in the bottom right panel and any chat messages are printed in the bottom left panel.

Chatting:

If you wish to send messages to the other players in the lobby, leftclick here and type your message. If you wish to whisper a private message to just one player, type <playername> and then the rest of your message.

Changing Rooms:
room or create a room of your own, leftclick on this button.

Joining Games:
If you want to join a game in this room or create one yourself, leftclick on this button.

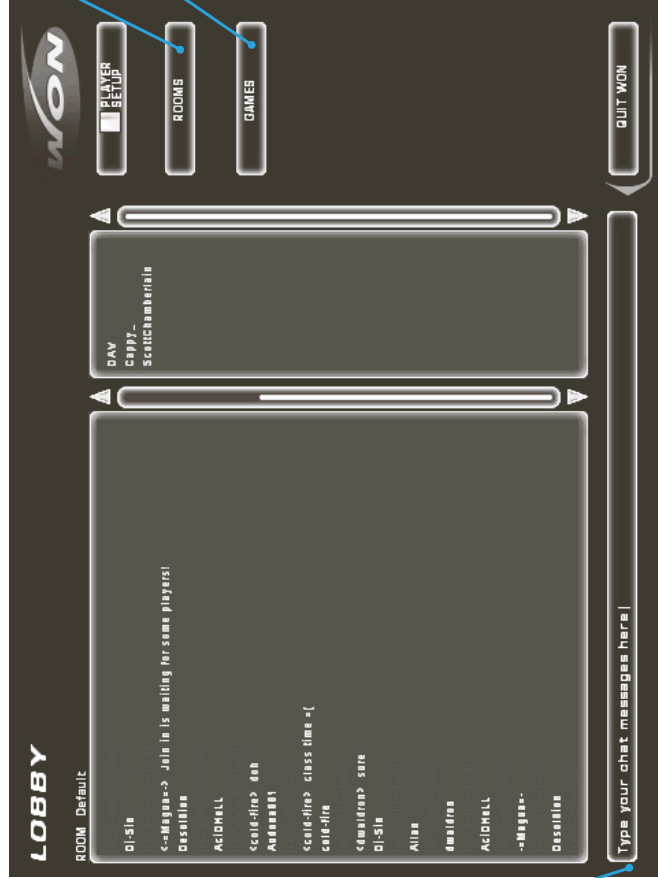

6.3.3 AVAILABLE GAMES

screen_shot

From this screen you can see a list of games in the room displayed in the large panel. You can join any of these games, view the options for each of them, update their ping times, or create your own game.

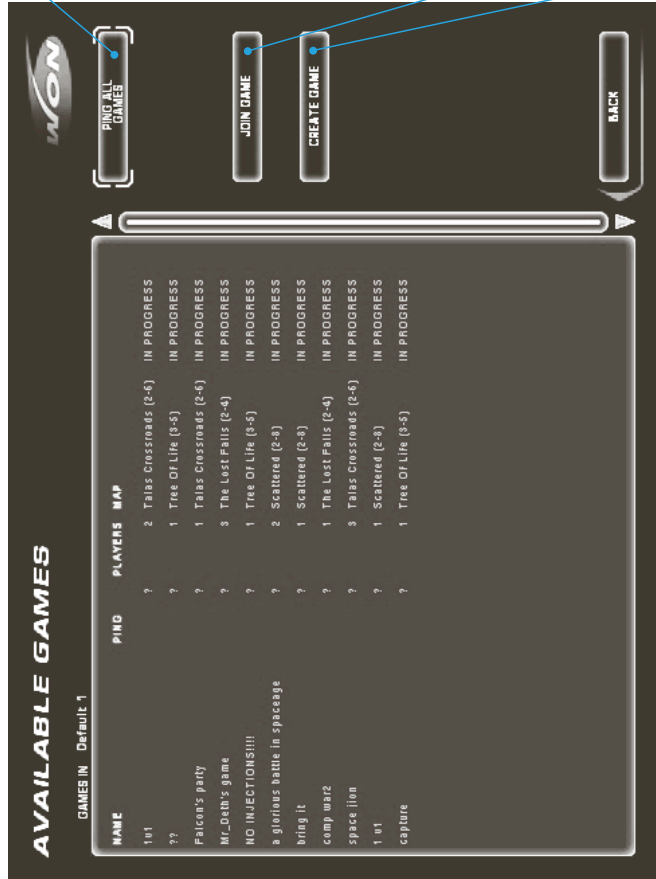

Updating Ping Times:
Leftclick on this button to update the ping times of all the games in the list. The lower the ping time, the faster your connection to the game will be.

Joining a Game:
Leftclick on the game you wish to join on the main list, then leftclick on this button.

Creating a Game:
Leftclick on this button to create a game in the current room. See "setting multiplayer game options" for more information on creating the game.

6.3.4 AVAILABLE ROOMS

screen shot

From this screen you can see a list of the rooms on WON in the large panel. You can join one of these rooms or create your own.

Joining a Room:
To join a room, first leftclick on its name in the list, then leftclick on the <JOIN ROOM> button.

Creating a Room:
To create a room, leftclick on the <CREATE ROOM> button and fill in the necessary information.

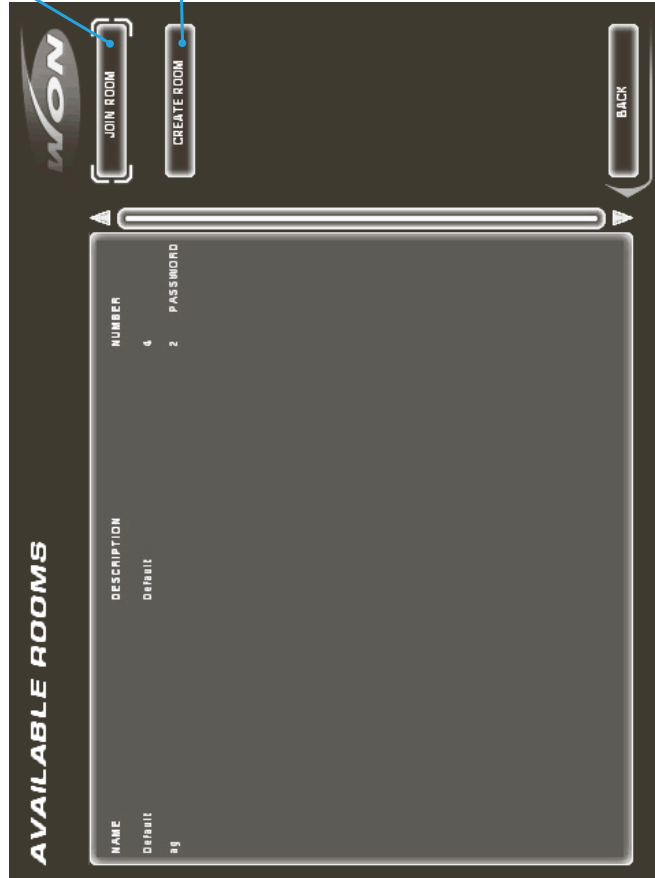

6.4 SET UP GAME MULTIPLAYER

screen_shot

Game Type:

Homeworld comes with several pre-defined setups for different styles of multiplayer gaming. Selecting one of these game types changes a variety of options on all of the options screens.

I Hate Harvesting:

No harvesting of resources is required in this game type. RU injections are turned on with a lump sum injection as well.

Bounty Hunter:

Bounties are turned on in this game type, meaning each enemy ship you kill brings in a bounty -- in RUs. Players with larger fleets have higher bounty ratings, making them more attractive targets.

Carpe Diem:

"Seize the day." This game type requires you to capture an enemy ship to win the game.

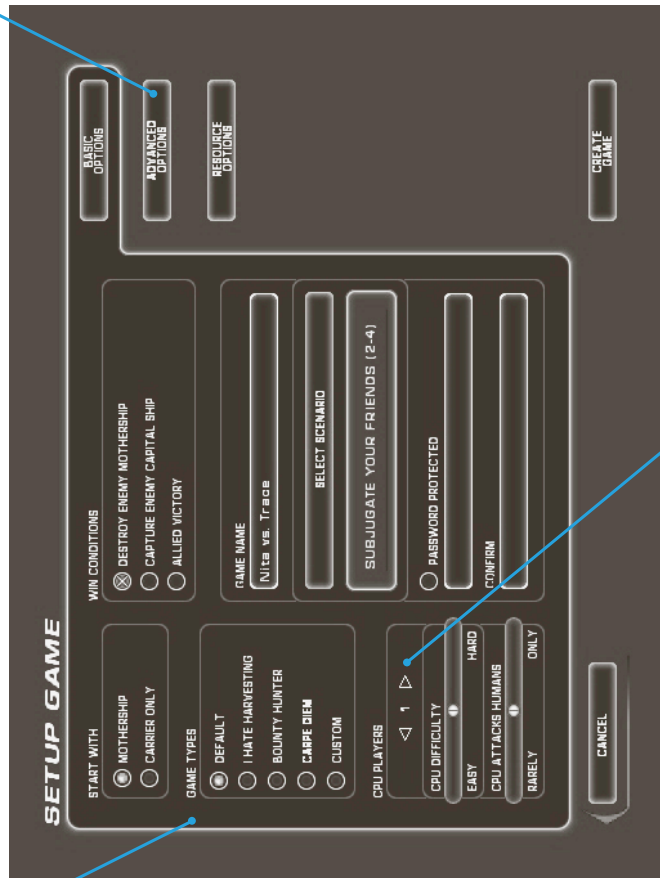

Basic Options:

Select Map:

This allows you to select in which location the multiplayer battle will take place. The number listed after the map name shows how many players that map supports.

CPU players:

This sets how many computer players will be present in a game.

Start With:

This option lets you decide if everyone starts the battle with a Mothership or only a Carrier.

Advanced Options:

Win Conditions:

This sets whether the game is won by destroying everyone's Mothership or by capturing an enemy Capital Ship.

Disable Research:

This option turns off the research model in the game and allows all players full access to all technologies from the beginning of the game.

Disable Crates:

If you toggle this off, no bonus crates will appear during the course of the game.

Disable Unit Capping:

This allows an unlimited number of vessels to be produced in the game. This can seriously slow down the game, even on the best of home computers.

Disable Fuel Burn:

If keeping track of fuel for Strike Craft (Fighters and Corvettes) is getting to be too much of a problem, turn off fuel consumption with this selection.

Allied Victory:

Checking this box will ensure that players who are allied can win a game together when they defeat players not in their alliance.

Bounties:

With this option toggled on, you get a bounty in RUs for every enemy unit you destroy. Larger units bring greater rewards.



6.5 Saving a Multiplayer Game:

While playing the game, hit the [ESC] key and then choose 'save game' from the options list. This option functions the same as it does in Single-Player mode.

6.6 Loading a Multiplayer Game:

From the multiplayer menu, leftclick on the <LOAD SAVED GAME> button to bring up a list of saved multiplayer games. Left click on a game in the list and then leftclick on the <LOAD GAME> button to load it.

6.7 Recording a Multiplayer Game:

Homeworld allows you to record any multiplayer game and watch it later, from any angle. When you wish to start recording a game, hit the [ESC] key and leftclick on the <RECORD> button. Follow the same process that you would if you were saving a game. You may load a recording at any time by leftclicking on <LOAD RECORDED GAME> from the multiplayer menu. Once loaded, you can focus on any ship in the world from the Sensors Manager, not just your own.

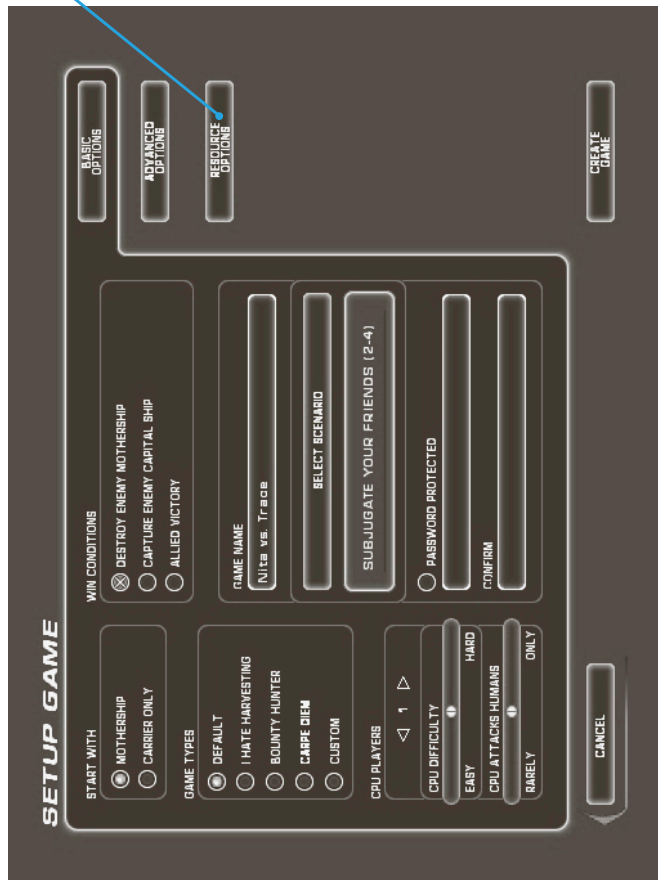

Resource Options:

Disable Harvesting:

This toggles resource collection on or off. With it off, you will have to toggle on some other supply of RUs or your game will run out of resources fairly quickly.

Starting Resources:

This sets the level of resources with which each side begins the scenario.

Resource Injections:

This section must be toggled on by leftclicking on the checkbox. You can then set how often players will receive a chunk of RUs, and how large that chunk is.

One Lump Sum:

If you toggle this option, you will receive only one lump sum of resources a certain amount of time after the game begins. Both the amount and timing of this precious gift can be set.

Player Options:

Selecting a Fleet:

Here you can choose to play either Kushan or Taidan in the game you are creating.

Choosing Ship Colors:

This screen lets you set the base and stripe colors of your ships. To change your base color, leftclick on the <BASE COLOR> button. A small white circle will appear inside the large rainbow box. Click and drag the circle around the

rainbow box until you have achieved a shade you are satisfied with. To change the stripe color, leftclick on the <STRIPE COLOR> button and repeat the same process of dragging the white circle to choose a stripe color. You can also drag the slider, located to the right of the rainbow box, up and down to adjust the brightness of the color.

1 INSTALLATION

Insert the CD-ROM into your CD-ROM drive. The Homeworld Installation program will automatically start up. Follow the on-screen instructions to specify the various installation options. When the installation is complete, it will have created a shortcut in your Start Menu that you can use to run Homeworld.

7 OPTIONS

The options menu can be accessed either from the opening menu or by hitting [ESC] at any time during a game. It gives you access to a number of gameplay and display options.

7.1 AUDIO OPTIONS

screen_shot

Num Channels:

This is the number of sound effects that the game will mix at one time. A high number of channels will give a more immersive experience but may adversely affect the frame rate of the game. Selecting auto allows the audio engine to turn off channels when the frame rate starts to get low, it will automatically increase the number of channels as the frame rate increases.

Volume Settings:

This section, consisting of three slider bars, allows you to set the volume levels for the game's speech, sound effects and music independently. Left-click, hold on the level indicator and drag the mouse

Multimedia Speakers:

This setting equalizes the audio engine for optimal performance with the average multimedia speaker system.

Stereo/Surround Sound:

This setting equalizes the audio engine for optimal performance with high end multimedia speakers or a home stereo.

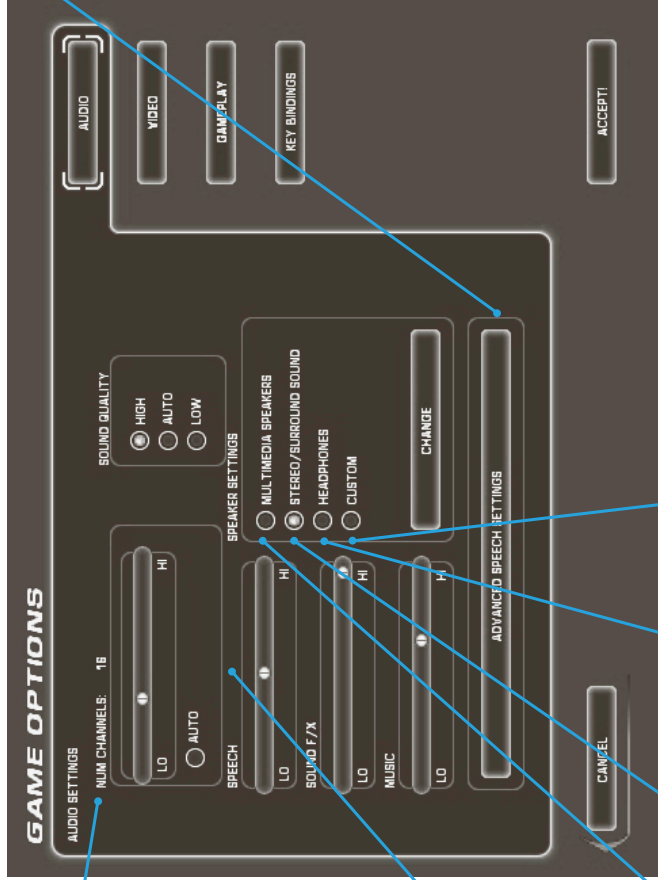

Advanced Speech Settings Menu:

Access this sub-menu by left-clicking on the <ADVANCED SPEECH SETTINGS> button. Left-click on the <ACCEPT> button when the options are set to your preference.

Vocal Settings:

This section allows you to pick which speech sounds are heard during the course of your game. Left-click on the check boxes to turn these sounds on or off. Command voices are the responses to your commands given during the game. Status reports are the voices that update you on new sensor reports, battles, and other goings-on in the game. Random chatter describes the voices of your various pilots and gunners as they perform their tasks, gloat over victories or yell for assistance. Random chatter is not vital to your situational awareness but adds greatly to the immersive quality of the game.

Voice Selection:

This section allows you to turn off any or all of the three voices used in the game. Left-click on the <HEAR> button to sample the voices.

Sound Quality:

High quality is the recommended setting. Selecting low quality will help increase the frame rate of the game. Selecting auto allows the audio engine to drop to low quality when the frame rate starts to get low, it will automatically go back to high quality when the frame rate increases.

NOTE: While playing a multiplayer game, you may change the music track you are listening to by pressing the [<] key to select the previous track or the [>] key to select the next track. The list of music tracks is limited to the ambient level tracks and battle tunes

Headphones:

This setting equalizes the audio engine for optimal performance with average headphones.

Custom:

By pressing the change button, you can tune the optimal equalization settings for your speakers or headphones.

7.2 VIDEO OPTIONS

screen_shot

Rendering System:

All systems that can run Homeworld will be able to run it in software. However, many users will have some form of hardware accelerator card that allows them to use Direct3D or OpenGL acceleration. This listbox lists the supported rendering systems Homeworld has detected on your system. The items listed in this window may include Software, Default OpenGL, 3DFx OpenGL and Direct3D Primary display. If you do not have a hardware accelerator for OpenGL, you will still have an option for Default OpenGL. Please note that this will be much slower than the Software option.

Level of Detail Threshold:

This slider bar controls the level of geometric complexity in rendered images. Sliding the bar to the left reduces the number of polygons in a single frame and results in chunkier looking ships. Adjust to achieve a balance between game performance and visual fidelity.

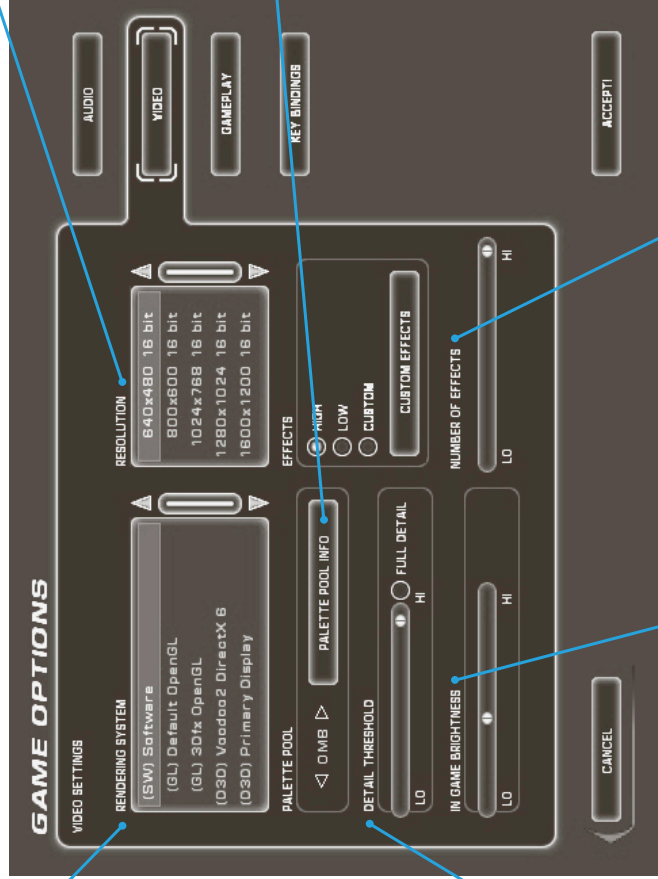

Resolution:

This panel displays the screen resolutions available for the rendering system you have chosen. Lower resolutions will speed up graphics at the cost of image smoothness and detail. Leftclick on the resolution setting you wish to use.

Palette Pool:

Certain video cards do not support paletted textures and require additional RAM to store temporary copies of the converted textures.

This control allows you to adjust how much memory is reserved for the texture pool. Increasing the size of the pool will decrease the amount of graphical slowdown that occurs when downloading textures to your video card. The control will be disabled if your hardware does not require this extra step.

In Game Brightness:

This Option affects how brightly the ships are rendered in the game. It does not effect the user interface screens or the backgrounds. You may want to turn this up to improve the brightness or contrast of the game depending on your monitor.

Number of Effects:

This slider effects how many effects are drawn in the game. Turning it up will result in a richer, more detailed game experience with more special effects but will also make it slower. To improve frame rate, you may want to turn this option down.



Custom Effects :

This sub-menu lets you choose which advanced graphic effects will be activated in your game. Each has its own cost in terms of performance, and its own benefits in terms of visual effects. A particular effect can be turned on or off by left clicking on the checkbox at the left of the feature name.

Surfacing Filtering:

Selecting this option will make textures appear smoother and less chunky. Surface filtering is not available when using the software rendering system.

Background Images:

This determines whether the galactic backdrop is displayed instead of the blackness of space. Users with slower machines, or those using the software rendering system, may want to turn this option off to speed up gameplay.

Stipple Alpha:

Selecting this option will cause the software rendering system to display transparency effects with a screen-door appearance, which results in higher graphic performance at the expense of visual quality.

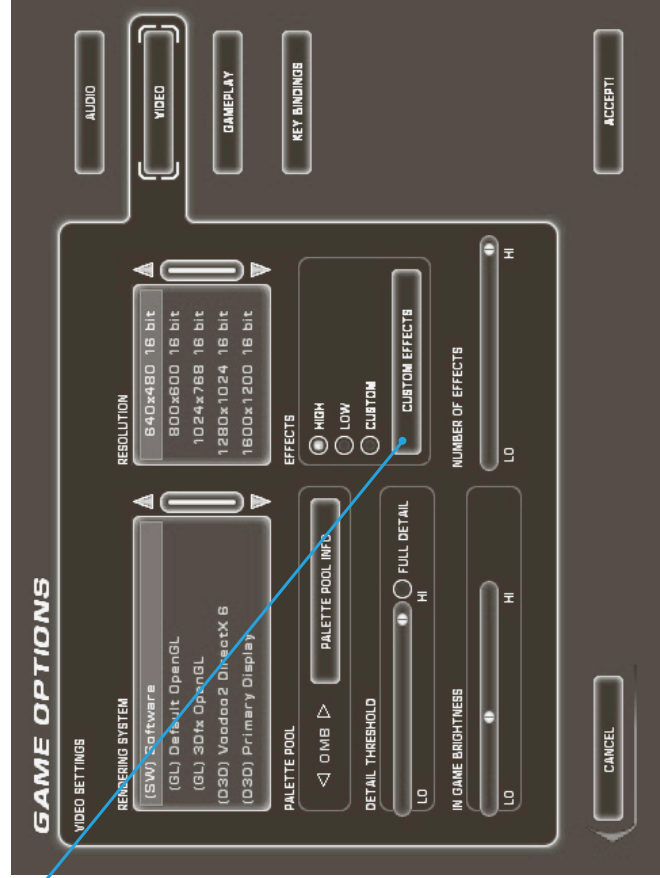
**Hit Effects:**

Turning this option off will disable bullet hit effects. These effects are played whenever bullets hit ships or other game objects. Owners of slower computers or without any hardware acceleration may want to disable this option to speed up the game during big battles. See also “Number of Effects” in the video options screen.

Damage Effects:

When ships get damaged, they may spark, smoke or emit flames. While this is an important gameplay element, rendering of these effects can cause a slow frame rate on slower machines or machines without hardware acceleration. Owners of these slower machines may want to disable these effects. See also “Number of Effects” in the video options screen.

Muzzle Flash Effects:

Turning this option off will disable effects that get played when ships fire bullets. Disabling this option may speed up the game on slower machines during big battles, but will not look as good. See also “Number of Effects” in the video options screen.

Bullet Effects:

Turning this option off will cause all bullets to be drawn with a simple bullet effect. This can improve the frame rate on slower machines during big battles, but will not look as good. See also “Number of Effects” in the video options screen.

Instant SM Transition:

Selecting this option causes the transition from the main game screen to the Sensors Manager to be immediate instead of smooth and fluid. Users with slower machines may want to enable the instant transition to improve response.

Blob Alpha:

Selecting this option will cause the circles in the Sensors Manager to be displayed with a faded fringe. Owners of slower computers may want to disable this option to speed up the display when in the Sensors Manager.

7.3 GAMEPLAY OPTIONS

screen_shot

Mouse Sensitivity:

This slider bar controls how much mouse motion it takes to move the cursor on the screen. Leftclick and drag the indicator to the left to make your cursor move more slowly and to the right to make it respond to mouse movement more quickly.

Info Overlay:

With this toggled on, every time you select a ship or group of ships, their type and number will appear in the upper right corner of the screen.

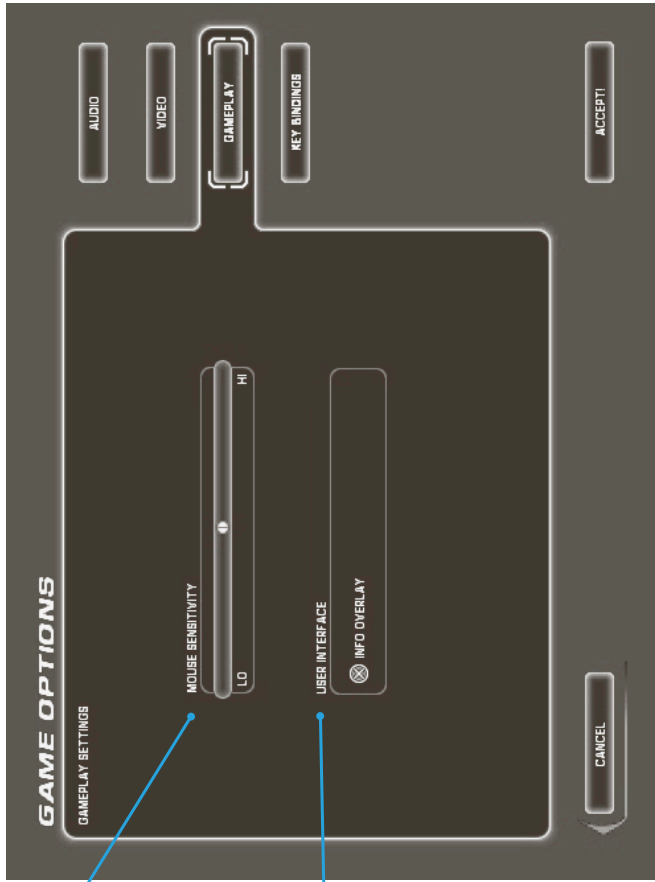

7.4 KEY BINDINGS

screen_shot

This menu allows you to change which gameplay commands are activated by which keystroke. To change a command key, doubleclick on the command you wish to change and press the new key you wish to trigger the command. Should you wish to erase all the changes you have made and return the command keys to their original assignments, leftclick on the <RESET TO DEFAULTS> button.

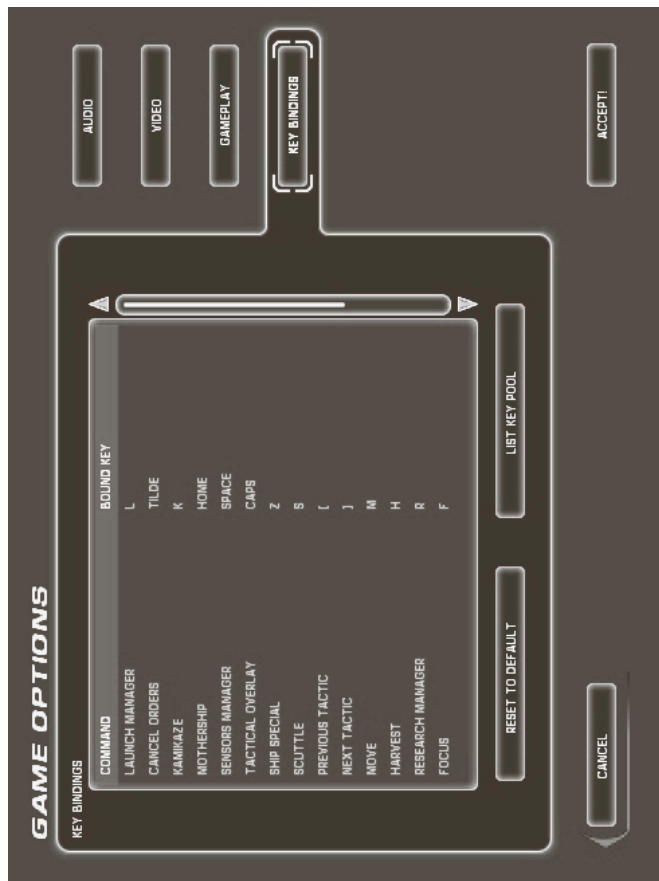

8.1 SHIP CATEGORIES

Ships in Homeworld are divided into several broad categories based on tonnage. Initially, no combat vessel larger than a Corvette is available, but through research all classes become available. Those classes are as follows:

Strike Craft:

This small ship class includes both Fighter and Corvette hulls. While highly maneuverable (Fighters are the only vessel class capable of performing special combat flight maneuvers), Strike Craft are unable to carry enough reactor mass to generate a self-sustaining drive torch, and so they must be refueled. This limits their range from the Mothership, unless a Support Frigate is provided to carry fuel for them. Strike Craft also are too small to carry the hyper drive module and cannot enter hyperspace by themselves.

Capital Ships:

This class represents the first generation of large crew vessels and includes the Frigate and Destroyer classes of warships along with the larger support vessels like the Cloak Generator, Resource Collector and Grav Well Generator. Capital Ships are the hard backbone of any attack fleet, and what they lack in speed and maneuverability is made up for in firepower and armor. Capital Ships have a limited self-repair capability.

Super Capital Ships:

These huge warships represent vast investments of resources, time and technology, and are as valuable as they are powerful. Second only to the massive Mothership in size and capability, these vessels are dreadnoughts of cutting edge-technology. They carry their own hyper drive modules and some even have onboard manufacturing arrays in order to replace ordinance or construct smaller vessels. While extremely powerful and able to absorb large amounts of damage, they are still vulnerable to masses of small ships and should never be deployed without a flotilla of smaller warships.





8.2 SHIP STATS AND DESCRIPTIONS

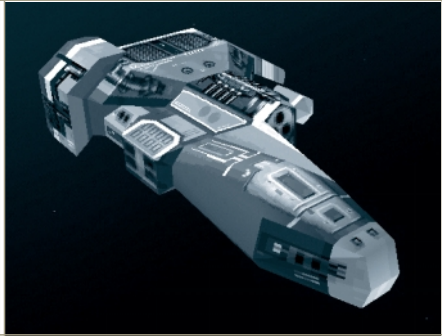
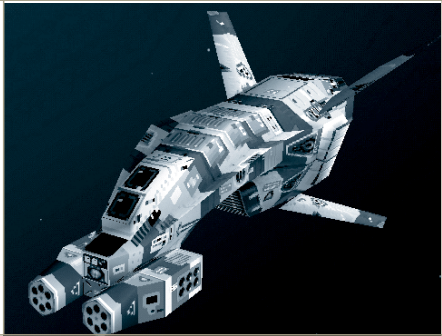

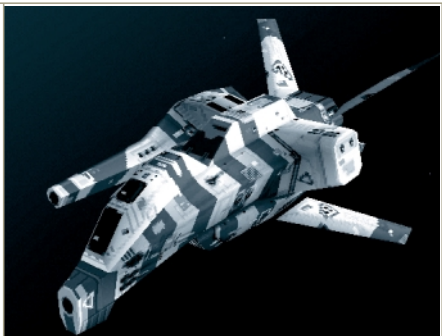
SOME DEFINITIONS:		
Mass:	The mass of the ship in tons	
Firepower:	The amount of damage the ship can inflict (relative weighting)	
Armor:	The amount of damage the ship's armored hull can withstand	
Coverage:	The percentage of a sphere the ship can cover with its guns	
Maneuverability:	How maneuverable and agile the ship is	
Max. Velocity:	The ship's top speed	

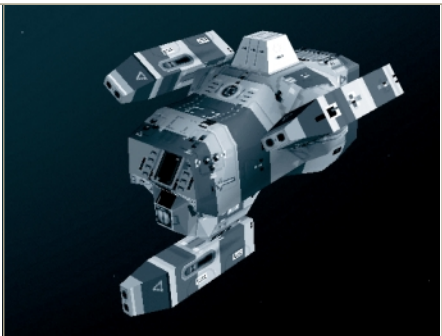
DESIGNATION		KUSHAN		TAIIDAN	
SCOUT					
DESCRIPTION		<p>True to its name, the Scout is a fast, cheap ship that is useful for scouting out enemy locations.</p> <p>Because of its high maneuverability, the Scout is excellent for creating diversions and light harassment while avoiding enemy fire.</p>			
		MASS:	40 TONS	MANEUVERABILITY:	VERY HIGH
		FIREPOWER:	10	MAX. VELOCITY:	1000m/s
		ARMOR:	110	SPECIAL FUNCTION:	SPEED BURST
		COVERAGE:	8%	(PRESS [Z] TO ACTIVATE)	
REQUIRED TECHNOLOGY:	NONE				

DESIGNATION		KUSHAN		TAIIDAN	
INTERCEPTOR					
DESCRIPTION		<p>While less maneuverable than the Scout, the Interceptor easily compensates with its much heavier weaponry. The Interceptor is a good Fighter killer and stacks up favorably against Capital Ships when used in greater numbers.</p>			
		MASS:	60 TONS	MANEUVERABILITY:	HIGH
		FIREPOWER:	18	MAX. VELOCITY:	875 m/s
		ARMOR:	160	SPECIAL FUNCTION:	NONE
		COVERAGE:	10%		
REQUIRED TECHNOLOGY:	FIGHTER DRIVE, HEAVY FIGHTER CHASSIS				

DESIGNATION		KUSHAN		TAIIDAN	
DEFENDER					
DESCRIPTION		<p>Although its slow speed keeps the Defender from being a primary attack force, its gimbaled guns and high power rotational thrusters allow it the greatest coverage of all Fighters.</p>			
		MASS:	60 TONS	MANEUVERABILITY:	HIGH
		FIREPOWER:	30	MAX. VELOCITY:	385 m/s
		ARMOR:	280	SPECIAL FUNCTION:	NONE
		COVERAGE:	90%		
REQUIRED TECHNOLOGY:	FIGHTER DRIVE, HEAVY FIGHTER CHASSIS, FIRE CONTROL				

DESIGNATION	KUSHAN	TAIDAN
CLOAKED FIGHTER		
DESCRIPTION	(KUSHAN ONLY)	
<p>With cloaking sails active, the Cloaked Fighter is the stealthiest ship around. Highly useful for simple surveillance, the Cloaked Fighter is also a good attack craft. It must, however, de-cloak to fire, making it vulnerable for a short period of time.</p>	MASS: 40 TONS	MANEUVERABILITY: HIGH
	FIREPOWER: 10	MAX. VELOCITY: 775 M/S
	ARMOR: 150	SPECIAL FUNCTION: CLOAKING (DOUBLECLICK OR: PRESS [Z] TO ACTIVATE)
	COVERAGE: 10%	
REQUIRED TECHNOLOGY:	FIGHTER DRIVE, HEAVY FIGHTER CHASSIS, CLOAKED FIGHTER	

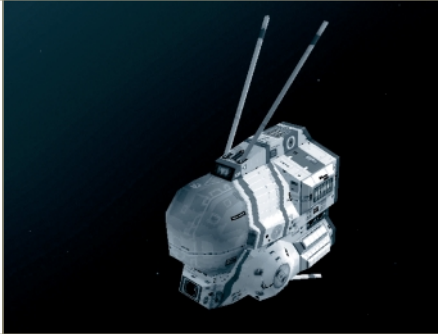

DESIGNATION	KUSHAN	TAIDAN
ATTACK BOMBER		
DESCRIPTION		
<p>A technological advance created plasma bomb technology small enough to fit in a Fighter-sized craft. The Attack Bomber was born. While its slow-moving plasma bombs can be outrun by Fighters, they make short work of Frigates and other Capital Ships.</p>	MASS: 90 TONS	MANEUVERABILITY: MEDIUM
	FIREPOWER: 45	MAX. VELOCITY: 700 M/S
	ARMOR: 300	SPECIAL FUNCTION: NONE
	COVERAGE: 5%	
REQUIRED TECHNOLOGY:	FIGHTER DRIVE, HEAVY FIGHTER CHASSIS, PLASMA BOMB LAUNCHER	

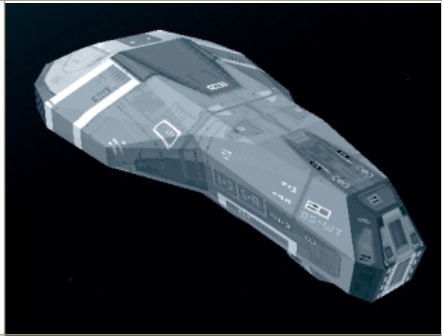
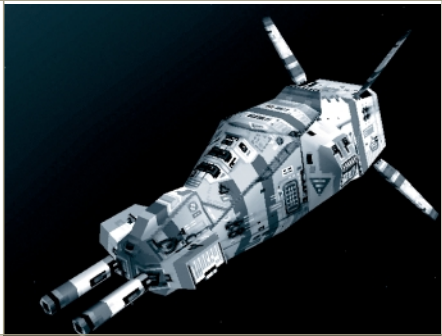
DESIGNATION	KUSHAN	TAIDAN
DEFENSE FIGHTER		
DESCRIPTION	(TAIDAN ONLY)	
<p>The Defense Fighter has no attack weaponry to speak of; instead, it fires beams from its emitter dome to shoot down oncoming enemy fire. This makes the Defense Fighter an excellent mobile protective force, especially when used with other Fighter craft.</p>	MASS: 75 TONS	MANEUVERABILITY: HIGH
	FIREPOWER: -	MAX. VELOCITY: 875 M/S
	ARMOR: 300	SPECIAL FUNCTION: NONE
	COVERAGE: 80%	
REQUIRED TECHNOLOGY:	FIGHTER DRIVE, HEAVY FIGHTER CHASSIS, DEFENSE FIGHTER	

DESIGNATION	KUSHAN	TAIIDAN																
LIGHT CORVETTE																		
DESCRIPTION	<table border="1"> <tr> <td>MASS:</td> <td>400 TONS</td> <td>MANEUVERABILITY:</td> <td>MEDIUM</td> </tr> <tr> <td>FIREPOWER:</td> <td>100</td> <td>MAX. VELOCITY:</td> <td>575 m/s</td> </tr> <tr> <td>ARMOR:</td> <td>900</td> <td>SPECIAL FUNCTION:</td> <td>NONE</td> </tr> <tr> <td>COVERAGE:</td> <td>40%</td> <td></td> <td></td> </tr> </table>		MASS:	400 TONS	MANEUVERABILITY:	MEDIUM	FIREPOWER:	100	MAX. VELOCITY:	575 m/s	ARMOR:	900	SPECIAL FUNCTION:	NONE	COVERAGE:	40%		
MASS:	400 TONS	MANEUVERABILITY:	MEDIUM															
FIREPOWER:	100	MAX. VELOCITY:	575 m/s															
ARMOR:	900	SPECIAL FUNCTION:	NONE															
COVERAGE:	40%																	
REQUIRED TECHNOLOGY:	CORVETTE DRIVE, CORVETTE CHASSIS																	

Its heavy-duty engine, chassis, and armor make the Light Corvette significantly slower than any of the Fighter-class ships.

Its salvation comes in a powerful turreted gun which is fast enough to hit Fighters flying at full speed.

DESIGNATION	KUSHAN	TAIIDAN																
HEAVY CORVETTE																		
DESCRIPTION	<table border="1"> <tr> <td>MASS:</td> <td>750 TONS</td> <td>MANEUVERABILITY:</td> <td>MEDIUM</td> </tr> <tr> <td>FIREPOWER:</td> <td>200</td> <td>MAX. VELOCITY:</td> <td>350</td> </tr> <tr> <td>ARMOR:</td> <td>1700</td> <td>SPECIAL FUNCTION:</td> <td>CHARGED BURST ATTACK</td> </tr> <tr> <td>COVERAGE:</td> <td>50%</td> <td colspan="2">(HOLD [Z] + LEFTCLICK ON THE TARGET TO ACTIVATE)</td> </tr> </table>		MASS:	750 TONS	MANEUVERABILITY:	MEDIUM	FIREPOWER:	200	MAX. VELOCITY:	350	ARMOR:	1700	SPECIAL FUNCTION:	CHARGED BURST ATTACK	COVERAGE:	50%	(HOLD [Z] + LEFTCLICK ON THE TARGET TO ACTIVATE)	
MASS:	750 TONS	MANEUVERABILITY:	MEDIUM															
FIREPOWER:	200	MAX. VELOCITY:	350															
ARMOR:	1700	SPECIAL FUNCTION:	CHARGED BURST ATTACK															
COVERAGE:	50%	(HOLD [Z] + LEFTCLICK ON THE TARGET TO ACTIVATE)																
REQUIRED TECHNOLOGY:	CORVETTE DRIVE, CORVETTE CHASSIS, HEAVY CORVETTE UPGRADE																	

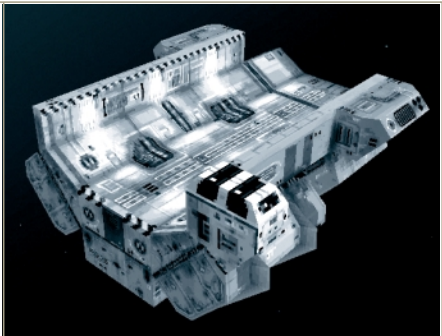

More armored than its light cousin, the Heavy Corvette adds a second high powered turret to an already powerful craft. Its turrets allow the Heavy Corvette to track two Fighters at once and also make it a moderate threat to Capital Ships.

DESIGNATION	KUSHAN	TAIIDAN																
REPAIR CORVETTE																		
DESCRIPTION	<table border="1"> <tr> <td>MASS:</td> <td>750 TONS</td> <td>MANEUVERABILITY:</td> <td>MEDIUM</td> </tr> <tr> <td>FIREPOWER:</td> <td>65</td> <td>MAX. VELOCITY:</td> <td>500 m/s</td> </tr> <tr> <td>ARMOR:</td> <td>1200</td> <td>SPECIAL FUNCTION:</td> <td>CAN REPAIR + REFUEL STRIKE</td> </tr> <tr> <td>COVERAGE:</td> <td>10%</td> <td colspan="2">CRAFT, REPAIR CAPITAL SHIPS. (HOLD [Z] + LEFTCLICK ON THE SHIP(S) TO SERVICE)</td> </tr> </table>		MASS:	750 TONS	MANEUVERABILITY:	MEDIUM	FIREPOWER:	65	MAX. VELOCITY:	500 m/s	ARMOR:	1200	SPECIAL FUNCTION:	CAN REPAIR + REFUEL STRIKE	COVERAGE:	10%	CRAFT, REPAIR CAPITAL SHIPS. (HOLD [Z] + LEFTCLICK ON THE SHIP(S) TO SERVICE)	
MASS:	750 TONS	MANEUVERABILITY:	MEDIUM															
FIREPOWER:	65	MAX. VELOCITY:	500 m/s															
ARMOR:	1200	SPECIAL FUNCTION:	CAN REPAIR + REFUEL STRIKE															
COVERAGE:	10%	CRAFT, REPAIR CAPITAL SHIPS. (HOLD [Z] + LEFTCLICK ON THE SHIP(S) TO SERVICE)																
REQUIRED TECHNOLOGY:	NONE																	

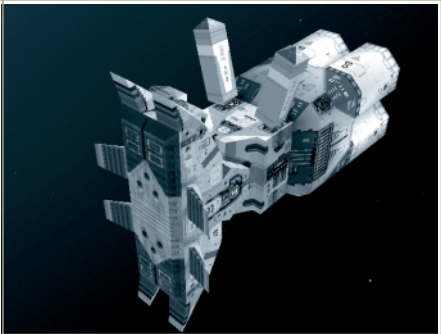
The Repair Corvette is capable of repairing and refueling Fighters “in the field.” While equipped with only a small gun, the Repair Corvette has heavy armor to protect itself and the craft it’s repairing. Timely support from a Repair Corvette can be quite useful in a long battle.

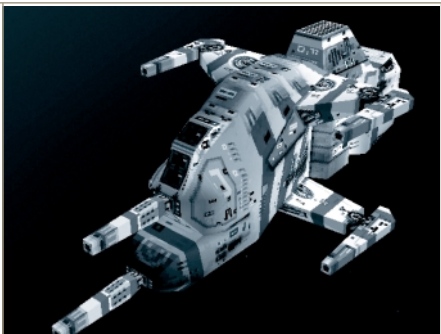
DESIGNATION	KUSHAN	TAIDAN
SALVAGE CORVETTE		
DESCRIPTION	<p>This beefy Corvette was once used exclusively for towing junk and salvaging derelicts. After being adapted for combat, the Salvage Corvette gained the ability to capture enemy ships that are heavily damaged. Once captured, these ships are towed back to a Carrier or the Mothership for refitting.</p>	
	MASS: 1200	MANEUVERABILITY: MEDIUM
	FIREPOWER: NA	MAX. VELOCITY: 425 M/S
	ARMOR: 1200	SPECIAL FUNCTION: CAPTURE OF ENEMY SHIPS
	COVERAGE: -	(LEFTCLICK ON ENEMY SHIPS TO ACTIVATE)
REQUIRED TECHNOLOGY:	CORVETTE DRIVE, CORVETTE CHASSIS	

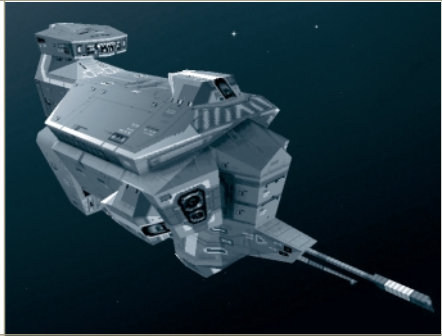
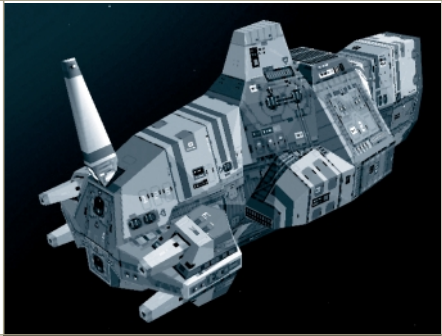

DESIGNATION	KUSHAN	TAIDAN
MULTI-GUN CORVETTE		
DESCRIPTION	<p>Following advances in turrets and auto-targeting, the Multi-Gun Corvette was conceived. It sports a full six articulating turrets. This allows it to track numerous fast-moving targets at once, making it especially deadly against large groups of Fighters.</p>	
	MASS: 750 TONS	MANEUVERABILITY: MEDIUM
	FIREPOWER: 180	MAX. VELOCITY: 695 M/S
	ARMOR: 1400	SPECIAL FUNCTION: NONE
	COVERAGE: 78%	
REQUIRED TECHNOLOGY:	CORVETTE DRIVE, CORVETTE CHASSIS, FAST TRACKING TURRETS	

DESIGNATION	KUSHAN	TAIDAN
MINELAYER CORVETTE		
DESCRIPTION	<p>While the Minelayer has normal attack capability (dropping mines that float slowly toward their target), it can also perform a force mine drop, where a wall of mines are laid at the current location. Running into a minefield with a fleet of Capital Ships is sure to ruin anyone's day.</p>	
	MASS: 900 TONS	MANEUVERABILITY: MEDIUM
	FIREPOWER: 300	MAX. VELOCITY: 425 M/S
	ARMOR: 800	SPECIAL FUNCTION: CREATION OF MINEFIELDS
	COVERAGE: -	(DOUBLECLICK OR: PRESS [Z] TO ACTIVATE)
REQUIRED TECHNOLOGY:	CORVETTE DRIVE, CORVETTE CHASSIS, MINELAYING TECH	

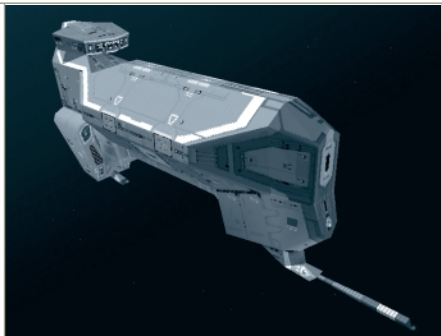
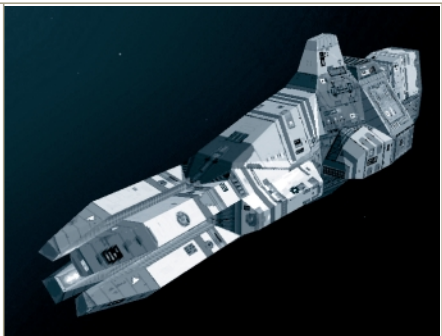
DESIGNATION	KUSHAN	TAIDAN																
ASSAULT FRIGATE																		
DESCRIPTION	<p>The Assault Frigate is the most general purpose combat ship of the capital ships. It has four large turrets, which afford it excellent coverage, as well as two fixed plasma bomb launchers. While its turrets are too slow to track fast-moving Fighters, they can take out the slower Corvettes with ease.</p>																	
REQUIRED TECHNOLOGY:	CAPITAL SHIP DRIVE, CAPITAL SHIP CHASSIS																	
	<table border="1"> <tr> <td>MASS:</td> <td>45,000</td> <td>MANEUVERABILITY:</td> <td>LOW</td> </tr> <tr> <td>FIREPOWER:</td> <td>2400</td> <td>MAX. VELOCITY:</td> <td>325 m/s</td> </tr> <tr> <td>ARMOR:</td> <td>16000</td> <td>SPECIAL FUNCTION:</td> <td>NONE</td> </tr> <tr> <td>COVERAGE:</td> <td>75%</td> <td></td> <td></td> </tr> </table>	MASS:	45,000	MANEUVERABILITY:	LOW	FIREPOWER:	2400	MAX. VELOCITY:	325 m/s	ARMOR:	16000	SPECIAL FUNCTION:	NONE	COVERAGE:	75%			
MASS:	45,000	MANEUVERABILITY:	LOW															
FIREPOWER:	2400	MAX. VELOCITY:	325 m/s															
ARMOR:	16000	SPECIAL FUNCTION:	NONE															
COVERAGE:	75%																	

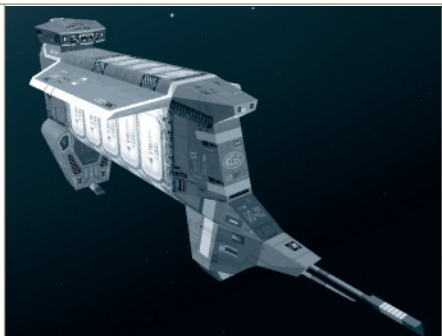
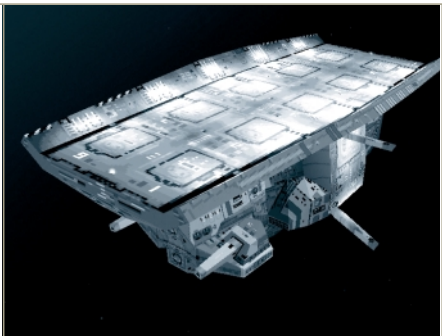
DESIGNATION	KUSHAN	TAIDAN																
ION CANNON FRIGATE																		
DESCRIPTION	<p>When ion beam power was harnessed, the scale necessary to produce a severely damaging beam meant that an entire Frigate could hold only one cannon. The acceleration ladder alone runs the entire length of the ship. What results is a devastatingly powerful, focused ion beam.</p>																	
REQUIRED TECHNOLOGY:	CAPITAL SHIP DRIVE, CAPITAL SHIP CHASSIS, ION CANNONS																	
	<table border="1"> <tr> <td>MASS:</td> <td>57,000</td> <td>MANEUVERABILITY:</td> <td>LOW</td> </tr> <tr> <td>FIREPOWER:</td> <td>4000</td> <td>MAX. VELOCITY:</td> <td>300 m/s</td> </tr> <tr> <td>ARMOR:</td> <td>15000</td> <td>SPECIAL FUNCTION:</td> <td>NONE</td> </tr> <tr> <td>COVERAGE:</td> <td>2%</td> <td></td> <td></td> </tr> </table>	MASS:	57,000	MANEUVERABILITY:	LOW	FIREPOWER:	4000	MAX. VELOCITY:	300 m/s	ARMOR:	15000	SPECIAL FUNCTION:	NONE	COVERAGE:	2%			
MASS:	57,000	MANEUVERABILITY:	LOW															
FIREPOWER:	4000	MAX. VELOCITY:	300 m/s															
ARMOR:	15000	SPECIAL FUNCTION:	NONE															
COVERAGE:	2%																	

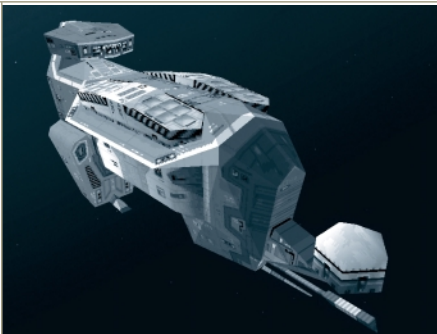
DESIGNATION	KUSHAN	TAIDAN																
SUPPORT FRIGATE																		
DESCRIPTION	<p>Giving support to Strike Craft in combat is the Support Frigate's main role. It has ten Fighter docking pads and four Corvette docking arms for repairing and refueling. Although it is well armored, the Support Frigate has only one large turret for defense and is best not left alone.</p>																	
REQUIRED TECHNOLOGY:	CAPITAL SHIP DRIVE																	
	<table border="1"> <tr> <td>MASS:</td> <td>45,000</td> <td>MANEUVERABILITY:</td> <td>LOW</td> </tr> <tr> <td>FIREPOWER:</td> <td>760</td> <td>MAX. VELOCITY:</td> <td>450m/s</td> </tr> <tr> <td>ARMOR:</td> <td>12000</td> <td>SPECIAL FUNCTION:</td> <td>CAN REPAIR + REFUEL STRIKE</td> </tr> <tr> <td>COVERAGE:</td> <td>15%</td> <td colspan="2">CRAFT (HOLD [z] + LEFTCLICK ON SHIP(S) TO SERVICE</td> </tr> </table>	MASS:	45,000	MANEUVERABILITY:	LOW	FIREPOWER:	760	MAX. VELOCITY:	450m/s	ARMOR:	12000	SPECIAL FUNCTION:	CAN REPAIR + REFUEL STRIKE	COVERAGE:	15%	CRAFT (HOLD [z] + LEFTCLICK ON SHIP(S) TO SERVICE		
MASS:	45,000	MANEUVERABILITY:	LOW															
FIREPOWER:	760	MAX. VELOCITY:	450m/s															
ARMOR:	12000	SPECIAL FUNCTION:	CAN REPAIR + REFUEL STRIKE															
COVERAGE:	15%	CRAFT (HOLD [z] + LEFTCLICK ON SHIP(S) TO SERVICE																

DESIGNATION	KUSHAN	TAIDAN
DRONE FRIGATE		
DESCRIPTION	(KUSHAN ONLY)	
<p>The Drone Frigate is essentially a holding and control system for the 24 drones it houses. These highly maneuverable drones each contain a powerful gun and, when launched, form a sphere around the Drone Frigate, giving it superb protection against Fighters.</p>	MASS: 60,000	MANEUVERABILITY: LOW
	FIREPOWER: 4900	MAX. VELOCITY: 325 M/S
	ARMOR: 16000	SPECIAL FUNCTION: DRONE LAUNCHING / RETRACTION:
	COVERAGE: 100%	(DOUBLECLICK OR: PRESS [Z] TO ACTIVATE)
REQUIRED TECHNOLOGY:	CAPITAL SHIP DRIVE, CAPITAL SHIP CHASSIS, DRONE TECHNOLOGY	

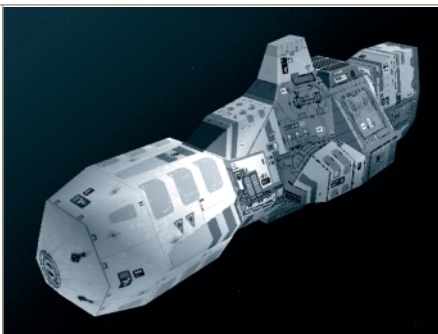
DESIGNATION	KUSHAN	TAIDAN
DEFENSE FIELD FRIGATE		
DESCRIPTION	(TAIDAN ONLY)	
<p>Like the Defense Fighter, the Defense Field Frigate has no attack capability. It can, however, deflect almost 100 percent of all oncoming enemy fire, with the exception of ion beams, mines, and missiles.</p>	MASS: 53,000	MANEUVERABILITY: LOW
	FIREPOWER: -	MAX. VELOCITY: 325 M/S
	ARMOR: 17600	SPECIAL FUNCTION: DEFENSE FIELD (ALWAYS ACTIVE)
	COVERAGE: 100%	
REQUIRED TECHNOLOGY:	CAPITAL SHIP DRIVE, CAPITAL SHIP CHASSIS, DEFENSE FIELD	

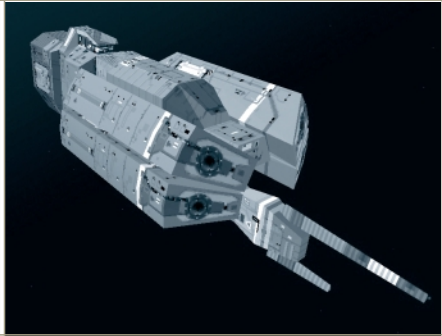
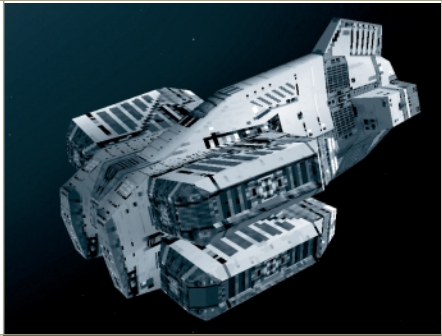
DESIGNATION		KUSHAN		TAIDAN	
MISSILE DESTROYER					
DESCRIPTION		<p>Although its total firepower is significantly less than that of a regular Destroyer, the guided missiles it launches make the Missile Destroyer a formidable foe to Strike Craft and Capital ships alike. For supply, the Missile Destroyer has a full missile manufacturing center in its belly.</p>			
MASS:	200,000	MANEUVERABILITY:	LOW		
FIREPOWER:	8500	MAX. VELOCITY:	295 m/s		
ARMOR:	42000	SPECIAL FUNCTION:	MISSILE VOLLEY ATTACK		
COVERAGE:	-	(HOLD [Z] AND LEFTCLICK ON THE TARGET TO ACTIVATE)			
REQUIRED TECHNOLOGY:	SUPER CAPITAL SHIP DRIVE, GUIDED MISSILES				

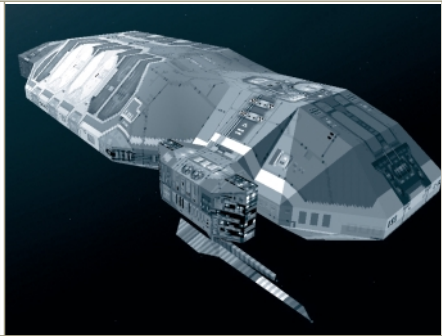
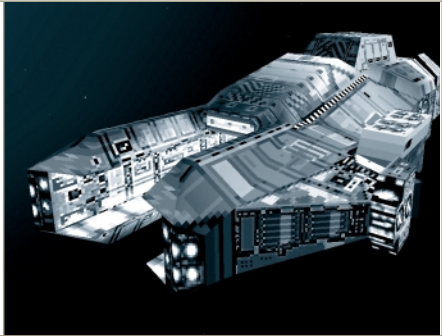
DESIGNATION		KUSHAN		TAIDAN	
CARRIER					
DESCRIPTION		<p>A veritable feat of engineering, the Carrier incorporates an entire construction center, capable of building up to Frigate-class ships. In addition, a huge docking array provides space for up to 50 Fighters and 25 Corvettes. Its rapid fire deck guns give it adequate defense.</p>			
MASS:	600,000	MANEUVERABILITY:	VERY LOW		
FIREPOWER:	4100	MAX. VELOCITY:	300 m/s		
ARMOR:	72000	SPECIAL FUNCTION:	CAN REPAIR AND REFUEL STRIKE		
COVERAGE:	60%	CRAFT. (HOLD [Z] AND LEFTCLICK ON THE SHIP(S) TO SERVICE)			
REQUIRED TECHNOLOGY:	SUPER CAPITAL SHIP DRIVE, SUPER HEAVY CHASSIS				

DESIGNATION		KUSHAN		TAIDAN	
HEAVY CRUISER					
DESCRIPTION		<p>The goliath of Capital Ships, this cruiser carries four twin-mounted ion cannons and six heavy turrets, each almost half the size of an entire Frigate. When a Heavy Cruiser shows up on the scene, things get really quiet really fast.</p>			
MASS:	800,000	MANEUVERABILITY:	VERY LOW		
FIREPOWER:	19,000	MAX. VELOCITY:	190 m/s		
ARMOR:	70000	SPECIAL FUNCTION:	NONE		
COVERAGE:	80%				
REQUIRED TECHNOLOGY:	SUPER CAPITAL SHIP DRIVE, SUPER HEAVY CHASSIS, HEAVY GUNS				

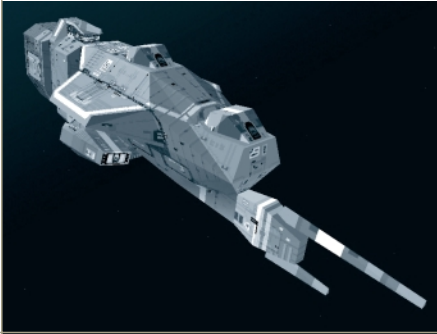
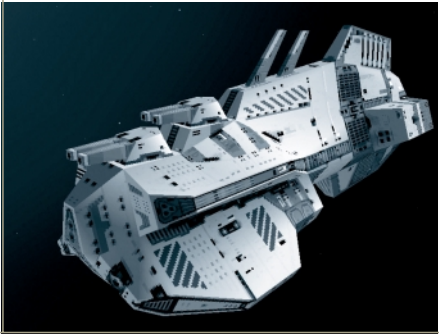

SUPER CAPITAL CLASS

8.2.21

DESIGNATION	KUSHAN		TAIDAN	
DESTROYER				
DESCRIPTION	<p>When it comes to taking down other Capital Ships, the Destroyer is a first choice. It has twin ion cannons and two modified large turrets. With maneuverability almost equal to a Frigate, the Destroyer is able to move around well in combat and react quickly to changes in the battle.</p>			
	MASS:	185,000	MANEUVERABILITY:	LOW
	FIREPOWER:	10500	MAX. VELOCITY:	315 M/S
	ARMOR:	44000	SPECIAL FUNCTION:	NONE
	COVERAGE:	35%		
REQUIRED TECHNOLOGY:	SUPER CAPITAL SHIP DRIVE			

MOTHERSHIP CLASS

8.2.22

DESIGNATION	KUSHAN		TAIDAN	
MOTHERSHIP				
DESCRIPTION	<p>The massive mothership contains three main sections: navigation, the fleet foundry, and cryogenics.</p> <p>Navigation analyzes local sensor data, the foundry provides complete construction capability, and cryogenics maintains the 500,000 colonists aboard.</p>			
	MASS:	5,000,000	MANEUVERABILITY:	-
	FIREPOWER:	7500	MAX. VELOCITY:	50M/S
	ARMOR:	160000	SPECIAL FUNCTION:	-
	COVERAGE:	60%		
REQUIRED TECHNOLOGY:	-			

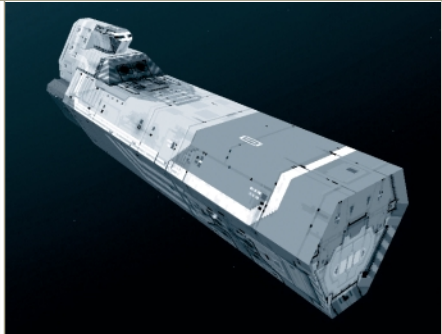
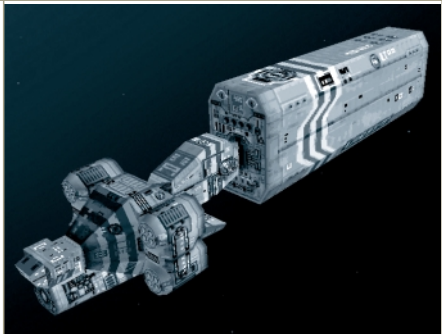
DESIGNATION		KUSHAN		TAIIDAN	
RESOURCE COLLECTOR					
DESCRIPTION		<p>Using a modified Phased Disassembler Array, the Resource Collector extracts at a molecular level the base elements in any resource. It then converts these elements into Resource Units, the generic term for base levels of material necessary for construction.</p>			
REQUIRED TECHNOLOGY:		NONE			
		MASS:	40,000	MANEUVERABILITY:	MEDIUM
		FIREPOWER:	-	MAX. VELOCITY:	300 m/s
		ARMOR:	10800	SPECIAL FUNCTION:	CAN REFUEL STRIKE CRAFT.
		COVERAGE:	-	(HOLD [Z] AND LEFTCLICK ON THE SHIP(S) TO SERVICE)	

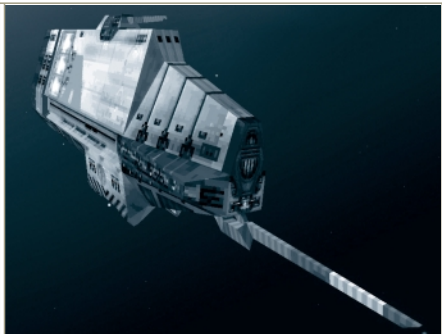
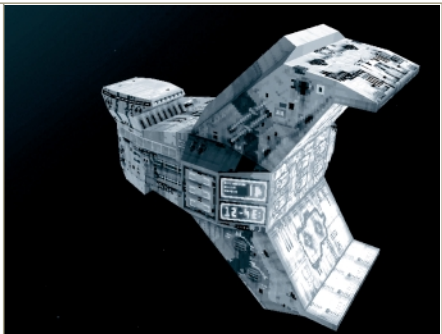
DESIGNATION		KUSHAN		TAIIDAN	
RESOURCE CONTROLLER					
DESCRIPTION		<p>The Resource Controller provides remote drop-off capability to the Resource Collector, minimizing time spent in transit. Additionally, it supports refueling of six Fighters and two Corvettes at once via its docking pads.</p>			
REQUIRED TECHNOLOGY:		CAPITAL SHIP DRIVE			
		MASS:	79,000	MANEUVERABILITY:	LOW
		FIREPOWER:	-	MAX. VELOCITY:	300 m/s
		ARMOR:	13600	SPECIAL FUNCTION:	CAN REFUEL STRIKE CRAFT.
		COVERAGE:	-	(HOLD [Z] AND LEFTCLICK ON THE SHIP(S) TO SERVICE)	

DESIGNATION		KUSHAN		TAIIDAN	
PROBE					
DESCRIPTION		<p>The Probe is outfitted with a one-time use engine which provides a huge power output for a short period of time. This results in very fast travel, but once in place the probe can't be moved again.</p>			
REQUIRED TECHNOLOGY:		NONE			
		MASS:	40 TONS	MANEUVERABILITY:	MEDIUM
		FIREPOWER:	-	MAX. VELOCITY:	4000 m/s
		ARMOR:	800	SPECIAL FUNCTION:	NONE
		COVERAGE:	-		

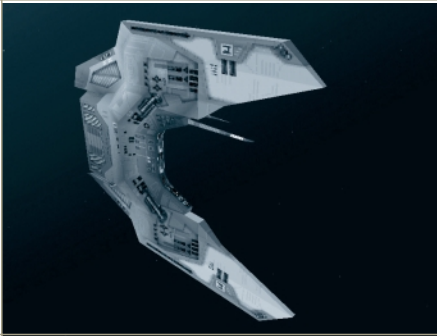
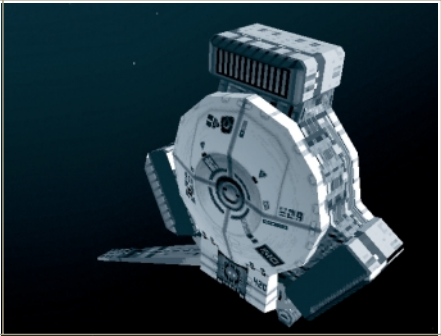
DESIGNATION	KUSHAN	TAIDAN
CLOAK GENERATOR		
DESCRIPTION	<p>The Cloak Generator creates a cloaking field large enough to contain up to two Frigates. Any ship inside the field is completely invisible except when firing. The generator can operate only for a fixed amount of time before recharging must occur.</p>	
	MASS: 22,000	MANEUVERABILITY: LOW
	FIREPOWER: -	MAX. VELOCITY: 325 M/S
	ARMOR: 6000	SPECIAL FUNCTION: CLOAKING (DOUBLECLICK OR: PRESS [Z] TO ACTIVATE)
	COVERAGE: -	
REQUIRED TECHNOLOGY:	CAPITAL SHIP DRIVE, CLOAK GENERATOR	

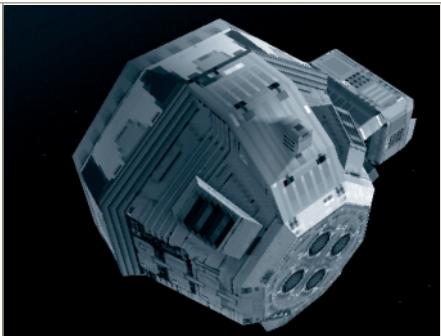
DESIGNATION	KUSHAN	TAIDAN
GRAV WELL GENERATOR		
DESCRIPTION	<p>The Gravity Well Generator creates a strong field around it which stops all Strike Craft in place. Gravity Well technology is less understood than cloaking and, as a result, the Grav Well's unstable field must be shut down after a certain amount of time and never restarted.</p>	
	MASS: 65,000	MANEUVERABILITY: LOW
	FIREPOWER: -	MAX. VELOCITY: 325
	ARMOR: 8000	SPECIAL FUNCTION: CAPTURES STRIKE CRAFT IN ITS FIELD (DOUBLECLICK OR: PRESS [Z] TO ACTIVATE)
	COVERAGE: -	
REQUIRED TECHNOLOGY:	CAPITAL SHIP DRIVE, GRAVITY GENERATOR	

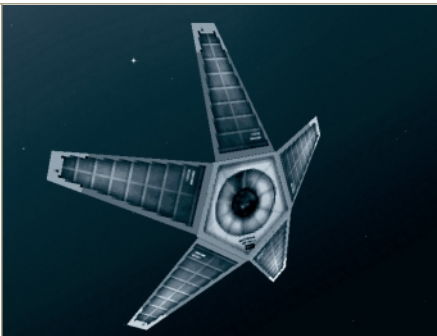
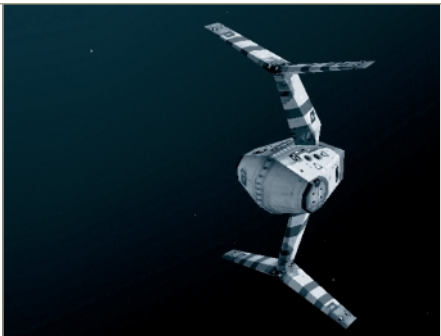
DESIGNATION	KUSHAN	TAIDAN
PROXIMITY SENSOR		
DESCRIPTION	<p>A remote sensor pack with an engine strapped onto it pretty much sums up the Proximity Sensor's. Beyond normal watch-dogging, its ability to detect cloaked vessels can make the lowly Proximity Sensor a handy ship to have around.</p>	
	MASS: 40 TONS	MANEUVERABILITY: VERY HIGH
	FIREPOWER: -	MAX. VELOCITY: 1000 M/S
	ARMOR: 800	SPECIAL FUNCTION: NONE
	COVERAGE: -	
REQUIRED TECHNOLOGY:	PROXIMITY DETECTOR	

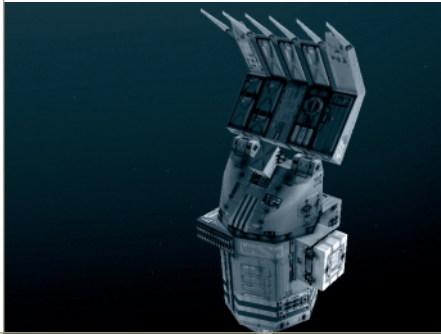
DESIGNATION		KUSHAN		TAIIDAN	
SENSORS ARRAY					
DESCRIPTION		Expanding the sensor ability of the Mothership with its larger-scale design, the Sensors Array provides full data on the local environment, letting you see the position and number of all enemy ships, as well as resource pockets.			
		MASS:	2900	MANEUVERABILITY:	LOW
		FIREPOWER:	-	MAX. VELOCITY:	280m/s
		ARMOR:	6000	SPECIAL FUNCTION:	NONE
		COVERAGE:	-		
REQUIRED TECHNOLOGY:	PROXIMITY DETECTOR, SENSOR ARRAY				

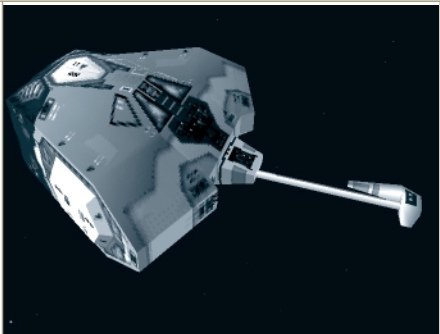
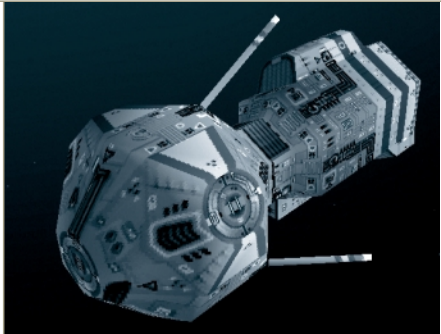
DESIGNATION		KUSHAN		TAIIDAN	
RESEARCH SHIP					
DESCRIPTION		Each Research Ship is a fully-functioning science facility that develops new technologies for the fleet. Newly-built Research Ships will link up with existing ones, increasing the aggregate armor of the facility.			
		MASS:	11,000	MANEUVERABILITY:	LOW
		FIREPOWER:	-	MAX. VELOCITY:	280 m/s
		ARMOR:	4500	SPECIAL FUNCTION:	NONE
		COVERAGE:	-		
REQUIRED TECHNOLOGY:	NONE				

DESIGNATION	
9.1 CAPITAL SHIP CHASSIS	
<p>The new heavy drives require a whole new hull technology based on heavily reinforced alloy skeletons that can bear the stress of multi-level decking and heavy weapon mounts. The groundwork has been laid to design the ship's spine to incorporate theoretically very heavy beam weapons. This breakthrough can be adapted to several special purpose designs as well as the creation of Frigate class warships. Scientists believe this chassis could lead to even more massive ship designs.</p>	

REQUIRED TECH:	CAPITAL SHIP DRIVE
LEADS TO:	CAPITAL SHIP PRODUCTION, ION CANNONS, SUPER CAPITAL SHIP DRIVE, SUPER HEAVY CHASSIS, GRAVITY GENERATOR, CLOAK GENERATOR
NEEDED FOR:	FRIGATE, ION CANNON FRIGATE, DRONE FRIGATE, DEFENSE FIELD FRIGATE.

DESIGNATION	
9.2 CAPITAL SHIP DRIVE	
<p>The advances in Strike Craft drives soon made it obvious that the next step in ship engineering should be drives large enough to achieve self-sustaining fusion torches while accelerating high mass vessels to combat speeds. The capital ship drive finally allows for vessels that do not require refueling.</p>	

REQUIRED TECH:	NONE
LEADS TO:	CAPITAL SHIP CHASSIS
NEEDED FOR:	FRIGATE, ION CANNON FRIGATE, DRONE FRIGATE, DEFENSE FIELD FRIGATE, SUPPORT FRIGATE, GRAVWELL GENERATOR, CLOAK GENERATOR, RESOURCE CONTROLLER

DESIGNATION	
9.3 SUPER-HEAVY CHASSIS	
<p>In an inspiration of design not seen since the Mothership was built, engineers have worked out the plans for the biggest and deadliest starships that can possibly be built by our manufacturing centers. The Heavy Cruiser and Carrier hulls based on this chassis require vast resources but should be considered the final words in offensive firepower and durability.</p>	

REQUIRED TECH:	CAPITAL SHIP CHASSIS
LEADS TO:	NOTHING
NEEDED FOR:	CARRIER, HEAVY CRUISER

DESIGNATION



9.4 CLOAKED FIGHTER (KUSHAN ONLY)

While researching electromagnetic ram-scoops, a Kushan scientist stumbled across a process by which intense fields could wrap photons around an object and render it invisible. Because the ratio between the size of the field and the mass of the generator kept the effect minimal, it was considered nothing more than a scientific curiosity. This was until a research team discovered that a generator large enough to emit electromagnetic fields just strong enough to render a Fighter invisible could be mounted on a Fighter chassis.

REQUIRED TECH:	FIGHTER CHASSIS
LEADS TO:	NOTHING
NEEDED FOR:	CLOAKED FIGHTER

DESIGNATION



9.5 CLOAK GENERATOR

Scientists have taken an entire Frigate hull and dedicated it to housing the electromagnetic field emitters needed to generate the strong light-warping field. The invisibility effect is an impressive one but requires every erg of power not going into propulsion and life support.

REQUIRED TECH:	CAPITAL SHIP CHASSIS
LEADS TO:	NOTHING
NEEDED FOR:	CLOAK GENERATOR

DESIGNATION



9.6 CORVETTE CHASSIS

With an improved engine, engineers were quickly able to expand their initial large utility hulls into a full-fledged combat chassis. This new generation of Strike Craft had large crew areas with multiple control stations which would open the door for heavy, multi-role Strike Craft with full turret capability and superior composite armor plating.

REQUIRED TECH:	CORVETTE DRIVE
LEADS TO:	HEAVY CORVETTE UPGRADE, FAST TRACKING TURRETS, MINELAYING TECH, CORVETTE PRODUCTION
NEEDED FOR:	LIGHT CORVETTE, SALVAGE CORVETTE, MULTI-GUN CORVETTE, HEAVY CORVETTE,
	MINELAYER CORVETTE

DESIGNATION	
9.7 CORVETTE DRIVE	
<p>This improvement to the Fighter drive trades mass for power. While far too big to wrap a Fighter around, this new drive is perfect for the Corvette class of ships. The higher power output allows for heavier weapon systems and powered turrets. Unfortunately, despite a higher degree of fusion efficiency, these drives still require reaction mass to be injected into the fusion torch and must be refueled regularly.</p>	
REQUIRED TECH:	NOTHING
LEADS TO:	CORVETTE CHASSIS
NEEDED FOR:	LIGHT CORVETTE, SALVAGE CORVETTE, MULTI-GUN CORVETTE, HEAVY CORVETTE, MINELAYER CORVETTE

DESIGNATION	
9.8 SUPER-CAPITAL SHIP DRIVE	
<p>The key to this giant drive system is to pulse and shape the torches of multiple fusion engines into one coherent thrust factor strong and stable enough to accelerate a huge mass without tearing the structure apart with oscillation instabilities. The super-capital class of drive systems is derived from mating the efficiency of the standard Capital Ship drive with power plants in the same league with the ones that power the Mothership herself. Not only does this drive system allow for the largest designs of warships but the incredible power output also makes possible new weapon systems.</p>	
REQUIRED TECH:	CAPITAL SHIP CHASSIS
LEADS TO:	HEAVY GUNS, GUIDED MISSILES
NEEDED FOR:	DESTROYER, MISSILE DESTROYER, CARRIER, HEAVY CRUISER

DESIGNATION	
9.9 DEFENSE FIGHTER (TAIIDAN ONLY)	
<p>Exploiting the Fighter frame even further, Taiidan scientists were able to produce a design capable of supporting the large Dome Array mounting which makes the Defense Laser possible.</p>	
REQUIRED TECH:	FIGHTER CHASSIS
LEADS TO:	NOTHING
NEEDED FOR:	DEFENSE FIGHTER

**9.10 DEFENSE FIELD (TAIDAN ONLY)**

The defense field is actually an extremely low frequency EM transmitter - 'mass wave' being the common name for extremely low frequency, high amplitude EM radiation. To broadcast waves with enough energy to block a cannon round, but at a low enough frequency to match that of the round's mass wave required extensive research and testing by Taiidan scientists. The system that was devised is so bulky that it could only be fitted on a Frigate chassis. It is never built into larger ships because of interference with other ship's systems. Special modification needed to be made to the drive systems of the Frigate chassis to make it possible to bear the distinctive white drum of the transmitting antenna.

REQUIRED TECH:	CAPITAL SHIP CHASSIS
LEADS TO:	NOTHING
NEEDED FOR:	FIELD FRIGATE

**9.11 DRONE TECHNOLOGY (KUSHAN)**

Scientists working on remote-controlled Fighters have joined forces with turret engineers to produce a small, free turret system that is basically a gun with a small station-keeping engine attached to it. While a single drone barely packs enough firepower to threaten a Scout, in larger numbers they can combine to create a storm of withering fire.

REQUIRED TECH:	CAPITAL SHIP CHASSIS
LEADS TO:	NOTHING
NEEDED FOR:	DRONE FRIGATE

**9.12 FAST-TRACKING TURRETS**

In an attempt to further increase fleet defense against high speed Fighter attacks, breakthroughs were made in both computerized tracking systems and high-speed magnetic couplings. Engineers combined these into a new series of fast-tracking turrets that can be mounted in multiple configurations on hulls as small as Corvettes. This ability to track multiple targets and engage them with separate turrets has allowed the creation of small gunships that can serve effectively in the anti-Fighter role.

REQUIRED TECH:	CORVETTE CHASSIS
LEADS TO:	NOTHING
NEEDED FOR:	MULTI-GUN CORVETTE

9.13 FIGHTER DRIVE

The first requirement for more powerful Strike Craft is a better engine. Fighter Drive technology allows us to modify the plasma ducting and reaction efficiency of our smallest reactors and create a whole new generation of high-performance Strike Craft that can carry heavier armor and payloads.

REQUIRED TECH:	NONE
LEADS TO:	FIGHTER CHASSIS
NEEDED FOR:	INTERCEPTOR, DEFENDER, CLOAKED FIGHTER, DEFENSE FIGHTER, ATTACK BOMBER

9.14 SENSOR ARRAY

Scientists from the Proximity Detector project went further into the study of discrete field effects and devised a localized sensor web that can increase resolution of passive scanning by a thousand-fold. This web can be imbedded in a specialized hull and is used to completely augment a command vessel's scanning and receiving capabilities, resulting in a full tactical view of the entire quadrant of space.

REQUIRED TECH:	PROXIMITY DETECTOR
LEADS TO:	NOTHING
NEEDED FOR:	SENSORS ARRAY

9.15 DEFENDER SUB-SYSTEMS

With the need for better space superiority systems, engineers have developed a whole new generation of targeting computer and sensor suites and combined them into specialized Fire Control systems. These new control systems can be adhered to gimbals mounted weapons to enable them to track and fire upon small, fast Strike Craft.

REQUIRED TECH:	FIGHTER CHASSIS
LEADS TO:	NOTHING
NEEDED FOR:	DEFENDER

DESIGNATION

9.16 GRAVITY GENERATOR

When the attempt to create a gravitational lensing system went awry, researchers found themselves with a runaway gravimetric distortion field and no way to escape -- their shuttle craft were pinned in the same intensified gravity field that was threatening to crush them. Luckily, a passing Assault Frigate was able to target the lab ships' engines and cut off power to the field generator. A decidedly refined version of this accidental effect became the Gravity Generator, which is capable of holding all Strike Craft within the gravimetric field until they are destroyed or the generator burns out.

REQUIRED TECH:	CAPITAL SHIP CHASSIS
LEADS TO:	NOTHING
NEEDED FOR:	GRAVWELL GENERATOR

DESIGNATION

9.17 GUIDED MISSILES

Missile technology has been available since the dawning days of space exploration but it has always been irrelevant as a weapon system because of its slow speed of any kind of non-fusion engine and the lack of a warhead that could effectively harm an armored starship. The plasma bomb solved the latter problem but it wasn't until the development of the Super Capital Ships, that a platform existed to house and power missiles that were large enough to carry the reaction mass needed to pursue a combat vessel. Using a variant of the stored plasma warhead, the guided missile actually draws superheated plasma into its internal magnetic containment field. When launched this field is then shaped and vented to simulate a traditional chemical rocket exhaust in order to give the missile high speed and maneuverability necessary to engage a fusion powered vessel.

REQUIRED TECH:	SUPER CAPITAL SHIP DRIVE
LEADS TO:	NOTHING
NEEDED FOR:	MISSILE DESTROYER

DESIGNATION

9.18 HEAVY CORVETTE UPGRADE

This breakthrough represents the pinnacle of Corvette class design and technology. The achievement here is beefing up the structural strength of the Corvette hull with advanced composites and EM field couplers so it can handle the stress of carrying a second heavy turret. Advancements in ablative armor techniques are the final part of an upgrade package that creates the most powerful Strike Craft in existence.

REQUIRED TECH:	CORVETTE CHASSIS
LEADS TO:	NOTHING
NEEDED FOR:	HEAVY CORVETTE

DESIGNATION	
9.19 FIGHTER CHASSIS	
<p>Once the full capabilities of the new Fighter drives are documented, scientists quickly will begin designing new frames that translate this power into better armor, longer range and heavier loadouts. The Fighter chassis is the blueprint for a new generation of heavy Fighters and Interceptors.</p>	
REQUIRED TECH:	FIGHTER DRIVE
LEADS TO:	FIGHTER PRODUCTION, DEFENDER SUB-SYSTEMS, PLASMA BOMB LAUNCHER, CLOAKED FIGHTER, DEFENSE FIGHTER
NEEDED FOR:	INTERCEPTOR, DEFENDER, CLOAKED FIGHTER, DEFENSE FIGHTER, ATTACK BOMBER

DESIGNATION	
9.20 HEAVY GUNS	
<p>The final advancement in ship power plants opened the door for truly massive bore mass drivers and the turrets needed to support them. Mounted only on Super Capital Ships, these new turrets are nearly the size of Frigates and pack enough power to cripple or destroy a smaller vessel in a single hit. These Heavy Gun systems are so massive that the magnetic couplings have to draw power directly from the main drive in order to rotate the weapon mount inside the turret housing.</p>	
REQUIRED TECH:	SUPER CAPITAL SHIP DRIVE
LEADS TO:	NOTHING
NEEDED FOR:	HEAVY CRUISER

DESIGNATION	
9.21 ION CANNONS	
<p>High-powered beam weapons are a tactician's dream and an engineer's nightmare. The size-to-power ratios were completely unworkable until the development of the Capital Ship chassis, which provided the room to employ a truly deadly directed beam of charged ions. The cannon draws power directly from the Capital Ship's main drive to supply not only the superheated hydrogen ions but also the tens of meters of super-conducting magnetic coil that focus and accelerate the beam. The Frigate chassis is just large enough to mount an ion cannon in a spinal arrangement.</p>	
REQUIRED TECH:	CAPITAL SHIP CHASSIS
LEADS TO:	NOTHING
NEEDED FOR:	ION CANNON FRIGATE, DESTROYER, HEAVY CRUISER

DESIGNATION

9.22 MINELAYING TECH

When scientists tried applying plasma bomb launcher technology to the larger Corvette hulls, they accessed a more powerful fusion drive that allowed them to experiment with the size of the plasma bomb containment field and new deployment methods. The development of super-dense plasma injectors made it possible to create a mine dispenser that would fit inside a Corvette hull and still be able to produce dozens of small plasma warheads designed to detonate on near contact with enemy hulls. With this technology, it's possible to create minefields around the Mothership at a moment's notice.

REQUIRED TECH:	CORVETTE CHASSIS
LEADS TO:	NOTHING
NEEDED FOR:	MINELAYER CORVETTE

DESIGNATION

9.23 PLASMA BOMB LAUNCHER

One of the benefits of a larger Fighter frame is the ability to modify a Strike Craft to carry powerful directed energy payloads. The plasma bomb system draws high-energy plasma from the Fighter's fusion torch drive and vents it into a small magnetic containment sphere mounted aboard a direct fire missile. The plasma venting occurs in the split second between the pilot firing the bomb and the bomb actually leaving its cradle. Upon impact with the target, the bomb's containment sphere ruptures and releases the near-fusion plasma in a single massive burst. While the missile is unable to accurately target fast-moving Strike Craft, it can be devastating to slower-moving Capital Ships. This ornate and powerful weapon system leaves a Strike Craft without any room to mount other weapons.

REQUIRED TECH:	FIGHTER CHASSIS
LEADS TO:	NOTHING
NEEDED FOR:	ATTACK BOMBER

DESIGNATION

9.24 PROXIMITY DETECTOR

Long range scanning has always been difficult since most active sensors can be easily fooled or fed false data. To compensate for this, scientists have designed small passive sensor packages fitted to modified missile engines. These sensor packages can be ordered to take up position anywhere within communication range and then direct beam back real time information about their local area of space.

REQUIRED TECH:	NONE
LEADS TO:	SENSOR ARRAY
NEEDED FOR:	PROXIMITY SENSOR

CREDITS

Director:

Alex Garden

Lead Designer:

Erin Daly

Lead Programmer:

Luke Moloney

Art Director:

Rob Cunningham

Lead Artist:

Aaron Kambeitz

Designers:

Adam Bullied

Quinn Duffy

Programmers:

Gary Shaw

Keith Hentschel

Falko Poiker

Darren Stone

Bryce Pasechnik

Drew Dunlop

Jason Dorie

Sound Programming:

Shane Alfreds

Janik Joire

Artists:

Arthur Shimizu

David T. Cheong

Kelly O'Hara

Erin Olorenshaw

Andy Lang

Art We

Music and Sound Effects:

Paul Ruskay

Studio X Production Labs

Vancouver, Canada

Roger Savoie

Headroom Studios

Vancouver, Canada

Executive Producer/COO:

Ron Moravek

CFO:

Curtis Terry

IT Support:

Frank Roberts

Pilot Voices:

David Sobolov

Ian James Corlett

Jason Wingham

Voice of Fleet Command:

Heidi Ernest

Voice of the Bentusi Traders:

Campbell Lane

Voice of Fleet Intelligence:

Michael Sunczyk

Additional Voices:

Brian Arnold

Tina Savoie

Lucas Wolf

Manual and Story Written by:

Montgomery E. Crabapple

Story Concept:

Dave “the Smoking Dog” Williams

Manual Graphic Design:

Rubber Oven Design

Manual Illustrations:

Tom Graham

Aaron Kambeitz

Rob Cunningham

Homeworld Website:

(www.homeworld.net)

Art Direction by Rubber

Oven Design

Design and production by

FirstWeb Communications

Astronomy Consultant:

Jaymie M. Matthews

Deep Space Dry

Methane Martinis:

Jaymie M. Matthews

Beta Testing:

The fine folks at Valve Software

The boys at Firing Squad

The Sierra crew

www.Homeworld.org

Clean Power provided by:

ESP Electronic Systems

Protection Inc.

Special Thanks:

Peter Elson

Chris Foss

Ralph McQuarrie

Joe Johnston
Nilo Rodis-Jamero
Rhett Brewer
Elijah's Mantle
Ridley Scott
Vangelis
Astronomy Magazine
Space Telescope Science Institute
Ed Konyha
Johan Thornton
HempBC
Cannabis Canada
Starbucks (Yaletown)
Subeez Cafe
The Cambie Bakery
The Elbow Room
Tigalo's
Rainman
The Lemon Grind
God (whoever She is)
Geoff Keighley
Dan McBride
Elliot Chin
Genevieve Ostergard
Jim "Don't hurt me..." Veevaert
Chris Taylor
Don Mattrick
Myriam Deschenes
Drew "Dude, I gotta go home" McLean
Kristi the Kick-Ass Costco lady from Maui
Dugald Mcpherson (Royal Bank of Canada)
Norman, for getting me into this business

Extra Special Thanks:

George Lucas, for the inspiration
Peter Molyneux, for the advice
Scott Lynch, for making everything possible

Special Thanks for Design:

Greg MacMartin
John Mavor

Special Thanks for Financial Consultation:

Lance "Kill 'em All!" Davis

Tolerance Thanks:

Erica
Paige
Monica Alfreds
Carol Duffy
Our families & friends (who don't remember us, but we still love them)

Sierra Studios

Senior Vice President:

Scott Lynch

General Manager:

Mark Hood

Director of Marketing:

Jim Veevaert

Product Managers:

Dan Amdur
Doug Lombardi

PR Manager:

Genevieve Ostergard

Creative Services:

Justin Kirby

QA

QA Manager:

Gary "Koros" Stevens

QA Supervisor:

Ken "Sunshine" Eaton



QA Leads:

Torsten “Uwajimaya” Reinl
Bernadette “Audona” Pryor

QA Analysts:

Erinn “Ares” Hamilton
Phil “Nautikus” Kuhlmeier
Andrew “Queen Mum” Coward
Danny “RosterCogburn” Harrison
Matt “Slinky” Julich
Marc “The Stalker” Nagel
Bryan “Kung-Fu Chicken” Walker
Lester “Mr. Wags” Stocker
Cade “Tre_D” Myers
Darren “Force Majeure” Beil
Chris “No Name” Mason

PC Technician:

Byron “Death’s Shadow” Hummel

Compatibility Lab:

Pat “Garden Weasel” Callahan

Titan Lead Engineer:

Stuart Seelye

Titan Engineers:

Brian Rothstein
Mike Nicolino
Erik De Bonte
Colen Garoutte-Carson
Lee Olds
Eric Harman

HOMEWORLD[®] COPYRIGHT 1997-1999

Sierra ON-LINE Inc. COPYRIGHT 1997-1999

Relic Entertainment Inc. MMCXVIII



END USER LICENSE AGREEMENT

1. Limited Use License

Sierra On-Line, Inc. (“Sierra”) hereby grants, and by installing the program you thereby accept, a limited, non-exclusive license and right to install and use one (1) copy of the program for your personal use on either a home or portable computer. You may not network the program or otherwise install it or use it on more than one computer at a time. The program may contain a level editor (the “editor”) that allows you to create custom levels, maps, courses or other materials for your personal, noncommercial use in connection with the program (“new materials”). All use of the editor is subject to this License Agreement. The program is licensed, not sold. Your license confers no title or ownership in the program.

2. Ownership

All title, ownership rights and intellectual property rights in and to the program and any and all copies thereof (including but not limited to any titles, computer code, themes, objects, characters, character names, stories, text, dialog, catch phrases, locations, concepts, artwork, animations, sounds, musical compositions, audio-visual effects, methods of operation, moral rights, any related documentation, and “applets” incorporated into the program) are owned by Sierra or its licensors. The program is protected by the copyright laws of the United States, international copyright treaties and conventions and other laws. All rights are reserved. The program may contain certain licensed materials and Sierra’s licensors may act to protect their rights in the event of any violation of this agreement.

3. Responsibilities of End User

A.

Subject to the grant of license hereinabove, you may not, in whole or in part, copy, photocopy, reproduce, translate, reverse engineer, derive source code from, modify, disassemble, decompile, or create derivative works based on the program, or remove any proprietary notices or labels on the program without the prior consent, in writing, of Sierra.

B.

The program is licensed to you as a single product. Its component parts may not be separated for use on more than one computer.

C.

You are entitled to use the program for your own personal use, but you are not entitled to:

(i) sell or transfer reproductions of the program to other parties in any way, nor to rent, lease or license the program to others.

(ii) exploit the program or any of its parts for any commercial purpose including, but not limited to, use at a cyber café, computer gaming center or any other location-based site;

(iii) use or allow third parties to use the editor and the new materials created thereby for commercial purposes including, but not limited to, distribution of new materials on a stand alone basis or packaged with other software or hardware through any and all distribution channels, including, but not limited to, retail sales and on-line electronic distribution without the express written consent of Sierra; and

(iv) host or provide matchmaking services for the program or emulate or redirect the communication protocols used by Sierra in the network feature of the program, if any, through protocol emulation, tunneling, modifying or adding components to the program, use of a utility program or any other techniques now known or hereafter developed, for any commercial purpose including, but not limited to commercial network play over the Internet, network play utilizing commercial gaming networks or as part of content aggregation networks; provided, however, you are permitted to host matchmaking services for the program for Internet play solely on a noncommercial basis (e.g., without charge of any kind and on a noncommercial site without any associated commercial activity, such as advertising or commercial linking or framing). Sierra has no liability and provides no warranty concerning Internet play performance of the program.

D.
You must back-up to another secure location, on a regular basis, any data files concerning your use of the program as Sierra has no liability for lost or corrupted data.



4. Program Transfer.

You may permanently transfer all of your rights under this License Agreement, provided the recipient agrees to the terms of this License Agreement and you agree to remove the program and any new materials from your home or portable computer.

5. Termination.

This License Agreement is effective until terminated. You may terminate the License Agreement at any time by destroying the program and any new materials. Sierra may, at its discretion, terminate this License Agreement in the event that you fail to comply with the terms and conditions contained herein. In such event, you must immediately destroy the program and any new materials.

6. Export Controls.

The program may not be re-exported, downloaded or otherwise exported into (or to a national or resident of) any country to which the U.S. has embargoed goods, or to anyone on the U.S. Treasury Department's list of Specially Designated Nationals or the U.S. Commerce Department's Table of Denial Orders. By installing the program, you are agreeing to the foregoing and you are representing and warranting that you are not located in, under the control of, or a national or resident of any such country or on any such list.

7. Limited Warranty.

SIERRA EXPRESSLY DISCLAIMS ANY WARRANTY FOR THE PROGRAM, EDITOR, AND MANUAL(S). THE PROGRAM, EDITOR, AND MANUAL(S) ARE PROVIDED "AS IS" WITHOUT WARRANTY OF ANY KIND, EITHER EXPRESS OR IMPLIED, INCLUDING, WITHOUT LIMITATION, THE IMPLIED WARRANTIES OF MERCHANTABILITY, FITNESS FOR A PARTICULAR PURPOSE, OR NONINFRINGEMENT. SIERRA FURTHER DISCLAIMS ALL WARRANTIES WITH REGARD TO YEAR 2000 COMPLIANCE OF THE SOFTWARE. SPECIFICALLY, SIERRA MAKES NO WARRANTIES THAT THE PERFORMANCE OR FUNCTIONALITY OF THE PROGRAM WILL NOT BE AFFECTED BY DATES PRIOR TO, DURING, OR AFTER THE YEAR 2000, OR THAT THE PROGRAM WILL BE CAPABLE OF CORRECTLY PROCESSING, PROVIDING, AND/OR RECEIVING DATE INFORMATION WITHIN AND BETWEEN CENTURIES, INCLUDING THE PROPER EXCHANGE OF DATE INFORMATION BETWEEN PRODUCTS OR APPLICATIONS. ANY WARRANTY AGAINST INFRINGEMENT THAT MAY BE PROVIDED IN SECTION 2-312(3) OF THE UNIFORM COMMERCIAL CODE AND/OR IN ANY OTHER COMPARABLE STATE STATUTE IS EXPRESSLY DISCLAIMED.



The entire risk arising out of use or performance of the program remains with you; however, Sierra warrants up to and including 90 days from the date of your purchase of the program that the master disk on which the program is furnished shall be free from defects in material and workmanship. In the event that the master disk proves to be defective during that time period, and upon presentation to Sierra of proof of purchase of the defective program, Sierra will at its option 1) correct any defect, 2) provide you with a product of equal or lesser value, or 3) refund your money.

8. Limitation of Liability.

NEITHER SIERRA, ITS PARENT, SUBSIDIARIES, AFFILIATES NOR LICENSORS SHALL BE LIABLE IN ANY WAY FOR LOSS OR DAMAGE OF ANY KIND RESULTING FROM THE USE OF THE PROGRAM OR EDITOR INCLUDING, BUT NOT LIMITED TO, LOSS OF GOODWILL, WORK STOPPAGE, COMPUTER FAILURE OR MALFUNCTION, DATA LOSS, DATA CORRUPTION OR ANY AND ALL OTHER COMMERCIAL DAMAGES OR LOSSES.

Some states do not allow the exclusion or limitation of incidental or consequential damages, or allow limitations on how long an implied warranty lasts, so the above limitations may not apply to you.

9. Equitable Remedies.

You hereby agree that Sierra would be irreparably damaged if the terms of this License Agreement were not specifically enforced, and therefore you agree that Sierra shall be entitled, without bond, other security, or proof of damages, to appropriate equitable remedies with respect to breaches of this License Agreement, in addition to such other remedies as Sierra may otherwise have available to it under applicable laws.

10. Miscellaneous.

This License Agreement shall be deemed to have been made and executed in the State of Washington and any dispute arising hereunder shall be resolved in accordance with the law of the State of Washington. You agree that any claim asserted in any legal proceeding by one of the parties against the other shall be commenced and maintained in any state or federal court located in the State of Washington, King County, having subject matter jurisdiction with respect to the dispute between the parties. This License Agreement may be amended, altered or modified only by an instrument in writing specifying such amendment, alteration or modification, which is executed by both parties. In the event that any provision of this License Agreement shall be held by a court or other tribunal of competent jurisdiction to be



unenforceable, such provision will be enforced to the maximum extent permissible and the remaining portions of this License Agreement shall remain in full force and effect.

You hereby acknowledge that you have read and understand the foregoing License Agreement and agree that the action of installing the program is an acknowledgment of your agreement to be bound by the terms and conditions of the License Agreement contained herein. You also acknowledge and agree that this License Agreement is the complete and exclusive statement of the agreement between Sierra and you and that the License Agreement supersedes any prior or contemporaneous agreement, either oral or written (including inconsistent statements in written materials and online help accompanying the program), and any other communications between Sierra and you.

THE SIERRA NO-RISK GUARANTEE

The Promise:

We want you to be happy with every Sierra product you purchase from us. Period. If for any reason you're unhappy with the program, return it within 90 days of your purchase for an exchange or a full refund.

The Only Catch:

You've got to tell us why you don't like the program. Otherwise, we'll never get any better. Send the program back to us within 90 days of your purchase, postage prepaid, along with your original, dated sales receipt and we promise we'll make things right.

Disk and or Manual Replacement:

Sierra On-Line Fulfillment
4100 West 190th Street
Torrance, CA 90504

Product Returns:*

Sierra On-Line Returns
4100 West 190th Street
Torrance, CA 90504

*Returns valid in North America only.

NOTE:

To replace defective CD-ROM(s) please send all CD-ROM(s) and a copy of your dated receipt to the above fulfillment address, if less than 90 days from



your purchase. After 90 days from your purchase, for replacement of defective programs, you must also include a \$10.00 check payable to Sierra On-Line, Inc. for shipping and handling fees along with all CD-ROM(s). For replacement program documentation, you must include a \$5.00 check payable to Sierra On-Line, Inc. for shipping and handling fees and a photocopy of the jewel case from the program. Payment must be made at the time of your request. **Sorry, no credit cards. Returns to this address valid in North America only.**

SIERRA HINT LINE

1-900-370-5583 (1-900-370-KLUE)

\$.95 per minute

You need a touch-tone phone and must be 18 years or older.

Available 24 hours a day, 7 days a week.

Call for comprehensive tips and hints which you can get only from Sierra.

In Canada, call 1-900-451-3356 at \$1.25/minute.

